

## Product Features:

- Compatible with Winmate M700DM8 Tablet PC
- Hold the tablet on the desk and support multiple I/O
- Supported I/O: 1 x COM, 1 x LAN, 2 x USB, DC-in (2.5Ø power jack input)
- Side I/O supported : 2 x USB

## Mechanical Drawing

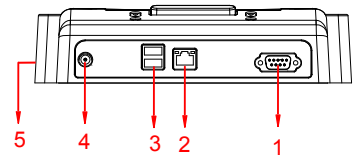
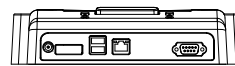
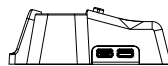
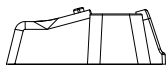
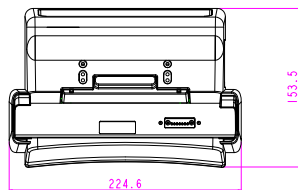

Front View

Side View

IO View

1. 1 x COM (RS232)
2. 1 x LAN (10/100)
3. 2 x USB

4. DC-IN (2.5Ø)
5. 2 x USB

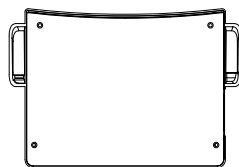

## Installation Procedure

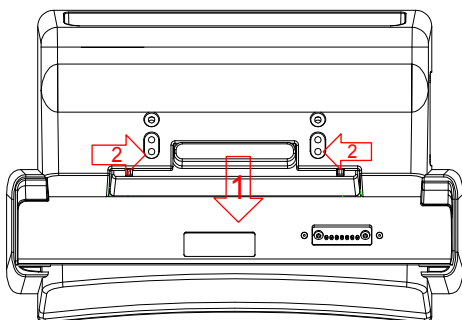

Top View

1. Pull down the latch
2. Insert the screw and tighten it
3. Insert the M700DM8 into the table docking, align the Pogo pin and make sure it is attached properly



Rear View

## Specification

Dimension	224.6 x 153.5 x 54.9 mm
Power Input	5V DC-in
I/O support	1 x COM, 1 x LAN, 2 x USB, DC-in (2.5Ø power jack)
Side I/O	2 x USB 2.0