

Smart Glasses
MOVERIO
BT-35E

EPSON[®]
EXCEED YOUR VISION

User's Guide



Information on the Moverio Website

Provides technical information.

<https://tech.moverio.epson.com/en/bt-35e/>

Contents



Safety Instructions	4	Using the Belt Clip/Cable Retainer	22
Notes on Usage	8	Replacing the Parts	24
Included Items	9	Attaching and Removing the Shade	24
Part Names and Functions	10	Replacing the Temple Grip	25
Interface Box	10	Replacing the Nose Pads	26
Headset	11	Supported Equipment and Software.....	27
Connecting the Interface Box		Updating the Firmware.....	28
and External Devices	12	Maintenance.....	29
Inputs and Outputs	12	Troubleshooting	30
Connecting by HDMI.....	13	Specifications.....	31
Connecting by USB Type-C.....	14	Product Specifications.....	31
Turning On/Displaying Images	16	Video Input	32
Standby Mode and AV Mute.....	17	Power.....	32
Extended Features	18	Intellectual Property Rights.....	33
Wearing the Headset.....	20	General Notes	34
Wearing over Glasses.....	21	List of Safety Symbols	36
Using the Shade.....	21	Contact List.....	38

User's Guide Organization



User's Guide	This guide provides information on safely using this product, basic operating methods, and troubleshooting. Make sure you read this guide before using the product.
Start Guide	Explains procedures for using this product for the first time.

Symbols Used in this Guide

■ Safety symbols

 Warning	This symbol indicates information that, if ignored, could possibly result in serious personal injury or even death due to incorrect handling.	 Caution	This symbol indicates information that, if ignored, could possibly result in personal injury or physical damage due to incorrect handling.
--	---	--	--

■ General information symbols

	Indicates procedures which may result in damage or injury if sufficient care is not taken.		Indicates additional information and points which may be useful to know regarding a topic.
[]	Indicates buttons and keys on the interface box.		Indicates a reference to related topics.

Safety Instructions

For your safety, read the attached documents carefully to use the product correctly. After you have read the documents, keep them in a safe place so that you can refer to them quickly at a later date.

Warning Usage environment and condition precautions

Only use this product at the stated power-supply voltage.

Only use the AC adapter and dedicated USB power supply cable supplied with the product. Using other power supply devices could result in heat, fire, explosion, malfunction, or liquid leakage.

Take the following precautions when handling the AC adapter. Failure to comply with these precautions could result in fire or electric shock.

- Do not plug the AC adapter into an outlet being used by many other devices.
- Do not insert the AC adapter into a dusty outlet.
- Insert the AC adapter firmly into the outlet.
- Do not hold the plug with wet hands.
- Do not cover or wrap the AC adapter in a cloth and so on.
- Do not use near a fire, stove, or electric heater.

Do not use the AC adapter, dedicated USB power supply cable, or USB Type-C cable if it is damaged. Failure to comply with these precautions could result in fire or electric shock.

For your safety, unplug the power supply cable when not using this product. The insulation may deteriorate, which may result in electric shock, fire, or malfunction.

Do not touch the plug during a thunderstorm. Failure to comply with these precautions could result in fire or electric shock.

Do not leave this product in locations subject to temperatures beyond the specified operating range, such as cars with the windows closed, in direct sunlight, or in front of air-conditioning or heater outlets. Also, avoid locations subject to sudden changes in temperature. Doing so may result in fire, breakdown, malfunction, or failure.

This product is not waterproof. Do not touch the AC adapter or the connectors and cables for each of the connector ports with wet hands. Failure to comply with these precautions could result in fire, burns, or electric shock.

Do not use the product in locations where it may get wet or is subject to high levels of humidity such as in a bath or shower. Failure to comply with these precautions could result in fire or electric shock.

Do not place this product in locations subject to smoke, steam, high humidity, or dust such as kitchen counters or near humidifiers. Doing so may result in fire, electric shock, or deterioration in image quality.

Do not cover this product with a cloth or similar material during use. Doing so may change the shape of the case through heat, or fire.

Do not touch the interface box for too long while it is operating. Doing so may result in low temperature burns if it is in contact with your skin for too long, even if it is in a pocket or over clothing.

Do not expose the camera lens to direct sunlight for a long time. Doing so may result in fire or explosion due to condensed beams of light from the lens.

Warning Product usage precautions



Do not start using this product at a high volume. Doing so may result in hearing impairment. Lower the volume before turning off the product, and gradually increase the volume after turning on the product. To prevent possible hearing damage, do not listen at high volume for prolonged periods of time.

Do not pull on the cable when inserting/removing it from the connector for the connector ports. Also, make sure you plug the connector straight into the connector port. If the connection is incomplete or incorrect, it could result in fire, burns, or electric shock.

Make sure you use genuine, certified products for cables connected to the USB-C port or the HDMI port. Failure to comply with these precautions could result in fire, burns, electric shock, or damage to the product due to incorrect wiring and so on when not using certified products.

Do not allow any conductive foreign objects to touch the external device connector or earphone microphone socket, and do not put any conductive foreign objects into the connection ports. Doing so may cause a short circuit and result in fire or electric shock.

Do not allow solvents such as alcohol, benzene, or thinner to touch the product. Also, do not clean this product with a wet cloth or solvents. Doing so may warp or crack the product housing and may result in electric shock, malfunction, or fire.

The product housing should only be opened by qualified service

personnel. Also, do not disassemble or remodel the product (including consumable items). Many of the parts inside the product carry a high voltage and could cause fire, electric shock, accident, or poisoning.

Do not subject the lens of the product to strong shocks or knock it against hard objects. If the lens is damaged, it could splinter and cause serious injuries to the eyes and face.

Do not throw the product into a fire and do not heat the product. Do not place objects with naked flames, such as candles, on this product. Doing so may result in heat, fire, or explosion.

Warning Viewing image precautions

Do not wear this product while driving a car, riding a motor bike or bicycle, or performing any other dangerous tasks. Doing so may result in accident or injury.

Do not use this product in unstable locations such as stairs or at altitude. Also, do not use the product while walking in dangerous locations such as near machinery or equipment that might get caught on the cables, where there is a lot of traffic, or where it is dark. Doing so may result in accident or injury.

When walking while viewing images on the product, be aware of your surroundings. If you are too focused on the image, it could result in accidents, falling down, and colliding with other people.

When viewing in dark locations, it is difficult to see your surroundings due to the brightness of the image. Be aware of your surroundings.

When using this product in small locations, be aware of your surroundings.

When wearing this product, do not look directly at the sun or other light sources even if you are using the shade. This could cause serious injury to your eyes or loss of eyesight.

Make sure the cable does not catch on anything in the surrounding area while wearing the product. Also, make sure the cable does not wind around your neck. Doing so may result in accident or injury.

Make sure the cable does not get damaged. Otherwise, it may result in fire or electric shock.

- Do not damage the cable.
- Do not place heavy objects on top of the cable.
- Do not bend, twist, or pull the cable with excessive force.
- Keep the power cable away from hot electrical appliances.

Warning Product abnormality precautions

In the following situations, unplug the power supply cable, and contact your local dealer or the Epson service call center. Continuing to use under these conditions may result in fire or electric shock. Do not try to repair this product yourself.

- If you see smoke, or notice any strange odors or noises.
- If any water, beverages, or foreign objects get into the product.
- If the product was dropped or the case was damaged.

Caution Usage environment and condition precautions

Do not place the product in locations subjected to vibrations or shocks.

While using the product to view images, play games, or listen to music, make sure you confirm the safety of your surroundings and do not leave any fragile items in your immediate vicinity. The images you are viewing may cause you to move your body involuntarily, resulting in damage to nearby items or personal injury.

Do not place this product near high-voltage lines or magnetized items. Doing so may result in breakdown, malfunction, or failure.

When performing maintenance, make sure you unplug the power supply cable and disconnect all wires. Otherwise, it may result in electric shock.

Caution Product usage precautions

Stop using this product if the skin that touches the product (face and so on) feels itchy when wearing the product, or any unusual rashes occur, and consult your local dermatologist.

If you sweat while using the product, wipe the sweat from your face and the product. Continuing to use under these conditions may result in itching or a rash.

For your own safety, do not use a conversion adapter or extension cable when using the USB-C port or the HDMI port.

Hold the interface box securely or place it on a stable surface and make sure the cables are not pulled with undue force.

Dispose of this product in accordance with your local laws and regulations.

Caution Viewing image precautions

Always take periodic breaks when viewing images using this product. Long periods of viewing images may result in eye fatigue. If you feel fatigued or uncomfortable even after taking a break, stop viewing immediately.

Do not drop this product or treat it with unnecessary force. Also, if the product breaks due to an impact such as a fall, stop using the product. Continuing to use this product may result in injury due to glass fragments.

When wearing this product, be aware of the edges of the frame. Also, do not place your finger between the moving parts of this product. Doing so may result in injury.

Make sure you are wearing this product correctly. Incorrect usage could make you feel nauseous.

This product should only be used for the purposes stated in the manuals. Doing so may result in injury.

If a problem or malfunction occurs, stop using this product immediately. Continuing to use this product may result in injury or could make you feel nauseous.

Stop using this product if your skin feels unusual when wearing this product and consult your local dermatologist. Sometimes allergies may occur due to the coating or material of the product.

How a 3D image is perceived varies depending on the individual. Stop using the 3D function if you feel strange or cannot see in 3D. Continuing to view the 3D images could make you feel nauseous.

This product must not be used by children under the age of six as their eyesight is still developing.

If a child of seven years or older uses the product, make sure they are supervised at all times and that they do not wear the product for extended periods. Pay close attention to the child's physical condition and make sure they are not suffering from eye strain.

Do not use this product if you are sensitive to light, or feel nauseous. Doing so may aggravate your pre-existing conditions.

Do not use this product if you have prior eye conditions. Doing so may aggravate the symptoms such as strabismus, amblyopia, or anisometropia.

Notes on Usage



This product uses an Si-OLED display panel. Due to the characteristics of the Si-OLED, you may notice burn-in or decreasing luminance on the panel. This is not a malfunction.

To reduce the burn-in, do the following.

- Do not display the same image for a long time.
- Hide markers or text that always appear in the same position.
- Decrease the display brightness.

List of Safety Symbols (corresponding to IEC60950-1 A2)

The following table lists the meaning of the safety symbols labeled on the equipment.

	Approved standards: IEC60417 No.5031
	Meaning: Direct current To indicate on the rating plate that the equipment is suitable for direct current only; to identify relevant terminals.

Caution Headset usage precautions

Do not drop this headset or treat it with unnecessary force.

The temples can only be opened outwards. Do not apply force in other directions. If excessive force is applied to the temples, they may be damaged.

When transporting the device, make sure you use the box that the device came in and a dedicated carrying case so as not to apply excessive force to the temples.

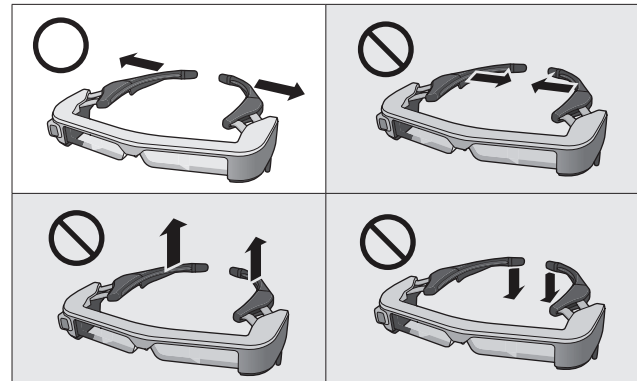

Included Items



Headset
➔ "Headset" p.11

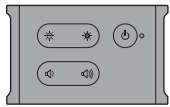

Interface box
➔ "Interface Box" p.10

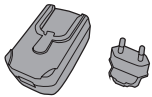

AC adapter
Plug attachment
➔ "Inputs and Outputs" p.12

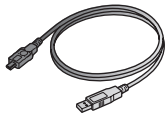

Dedicated USB power supply cable
➔ "Inputs and Outputs" p.12



Shade unit
➔ "Attaching and Removing the Shade" p.24

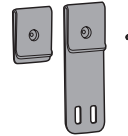

Belt clip
Cable retainer
Installation screw
➔ "Using the Belt Clip/Cable Retainer" p.22

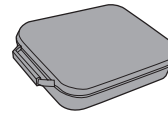

Carrying case
*Not waterproof.

Part Names and Functions

Interface Box

[⏻] (Standby) button

Set and release standby mode and AV mute, and show/hide images.

➔ "Standby Mode and AV Mute" p.17

[☀️ / 🌑] (Brightness adjustment) keys

Adjusts the brightness incrementally within a range of 0 to 20. Hold the keys down to increase or decrease the brightness.

[🔊 / 🔇] (Volume) keys

Adjusts the volume incrementally within a range of 0 to 15. Hold the keys down to increase or decrease the volume.

Headset connector

Connects the headset.

➔ "Connecting by HDMI" p.13

➔ "Connecting by USB Type-C" p.14

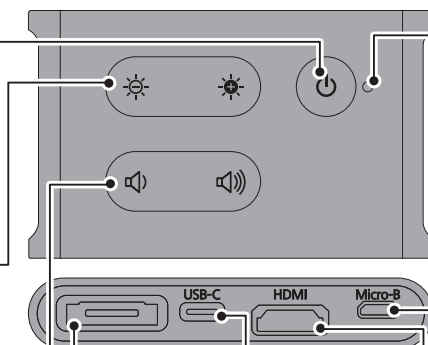

USB-C port

Connects to external devices that support USB Type-C. You can input video signals and supply power from the connected device. You can also output camera data and sensor data from the headset to the connected device.

➔ "Connecting by USB Type-C" p.14

LED indicator

Indicates the status of the product.

Orange: On	Standby mode
Blue: Flashing	No video signal detected
Blue: On	Displaying images
Blue: Flashing slowly	AV mute enabled
Orange: Flashing	Error has occurred

Micro-B port

This port is dedicated to supplying power. (It cannot be used for data communication.)

HDMI port

Inputs video signals from video equipment or computers that support HDMI.

➔ "Connecting by HDMI" p.13

Headset

Temple grip

If the temple grip gets dirty or deteriorates, it can be replaced.

➔ "Replacing the Temple Grip" p.25

Ambient light sensor

Senses the brightness of your surroundings and automatically adjusts the brightness of the screen.

Camera

Captures images and movies. Remove the protective film before use.

Interface box connector

Inserts into the interface box.

➔ "Connecting by HDMI" p.13

➔ "Connecting by USB Type-C" p.14

Temples

Open the temples to wear.

➔ "Wearing the Headset" p.20

Nose pads

If the nose pads get dirty, it can be replaced.

➔ "Replacing the Nose Pads" p.26

Shade

Shades from too much surrounding ambient light.

➔ "Attaching and Removing the Shade" p.24

Earphone microphone socket

You can connect commercially available earphone microphones.

➔ "Wearing the Headset" p.20

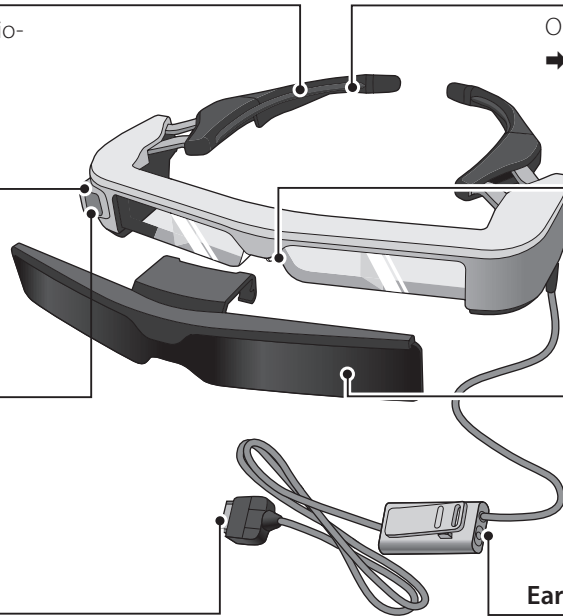

Connecting the Interface Box and External Devices

Inputs and Outputs

The interface box and external devices input/output the following data and power supply.

Port Name	Input/Output
USB-C	<ul style="list-style-type: none">• Outputs camera or sensor data.• Inputs video signals.• Supplies power.
HDMI	Inputs video signals.
Micro-B	Only supplies power. (Connects the AC adapter with the dedicated USB power supply cable.)



USB Type-C cables and HDMI cables are not supplied with this product. You need to prepare one in advance.

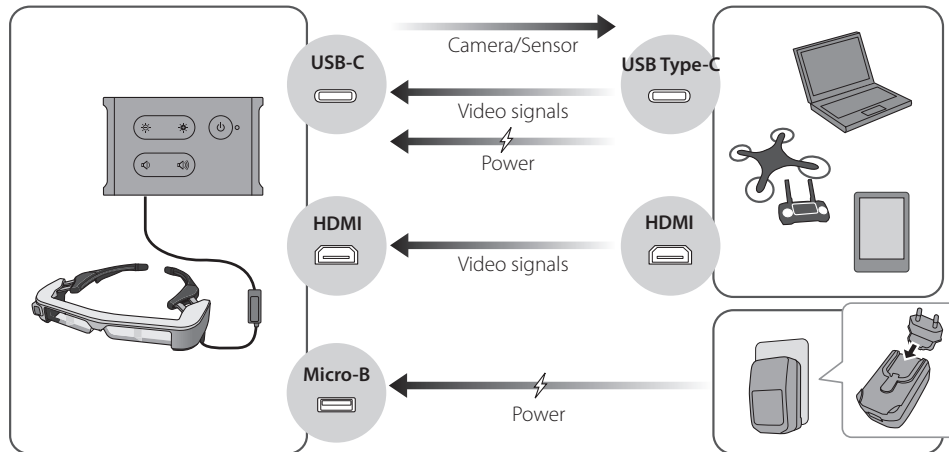

Connecting the Interface Box and External Devices

Connecting by HDMI

Follow the steps below to display images from external devices connected by HDMI.

1 Connect the headset.

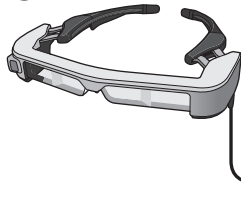

3 Connect the power supply.

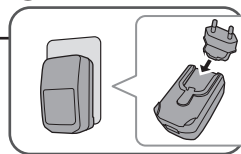

2 Connect the external device.

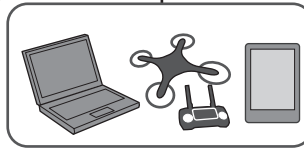

When using the headset sensor or camera data, connect to the USB-C port. Video signals from the HDMI port have priority over video signals from the USB-C port.

➔ **"When using the headset sensors or camera" p.15**



- Make sure you connect the headset before you connect the power supply.
- Do not connect or disconnect the headset while it is operating.
- Make sure you unplug the dedicated USB power supply cable before unplugging the headset cable.
- HDMI cannot be connected using a conversion adapter.
- To prevent the connection ports from wearing through usage, do not disassemble the AC adapter once it has been assembled.

Connecting the Interface Box and External Devices

Connecting by USB Type-C

When connecting to an external device with USB Type-C, you can use data from the headset sensors and camera as well as view the images. Also, since it can be used as a power supply source, you can perform three operations simultaneously using one USB Type-C cable; input video signals, output sensor/camera data, and supply power.

1 Connect the headset.

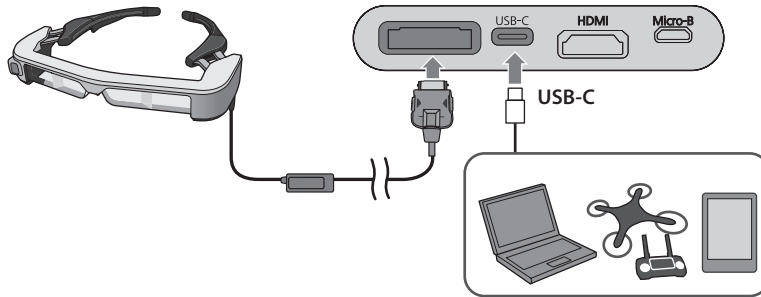

2 Connect the external device.



- Make sure you connect the headset before you connect the power supply.
- Do not connect or disconnect the headset while it is operating.
- Make sure you unplug the USB Type-C cable before unplugging the headset cable.
- The connected equipment must support USB 2.0/3.0.
- Make sure you use a genuine USB certified USB Type-C cable.
- USB Type-C cannot be connected using a conversion adapter.

Connecting the Interface Box and External Devices

Notes on displaying images by USB Type-C

- This product supports DisplayPort Alternate mode (DP Alt mode) for USB Type-C.
 - ➔ **"Supported Equipment and Software" p.27**
- To display images using USB Type-C, the connected device must support video output by USB Type-C.
- Depending on the device, displaying images may not be supported. See the manual supplied with the equipment you want to connect for more information.

Notes on supplying power by USB Type-C

- This product supports USB Type-C Current @ 1.5 A.
- Check that the connected equipment supports a power supply of 5 V/1.5 A or more by USB Type-C.
- If power cannot be supplied from the connected equipment, connect the AC adapter supplying power to the Micro-B port.
- Power supplied from the Micro-B port has priority over this product. If you change power supply during use, the product turns off temporarily.
If you are using the sensor/camera feature, make sure you re-configure the connected device as necessary.

When using the headset sensors or camera

Data from the sensors and camera built into the headset are output from the USB-C port. Some devices do not support the use of data from sensors or cameras. See the following for more details.

➔ **"Supported Equipment and Software" p.27**

Turning On/Displaying Images

When power is supplied from the Micro-B port or USB-C port, this product turns on. Also, when a video signal is being input, the video is displayed automatically.

When no video signal is being input, **< No Signal >** is shown on the display.

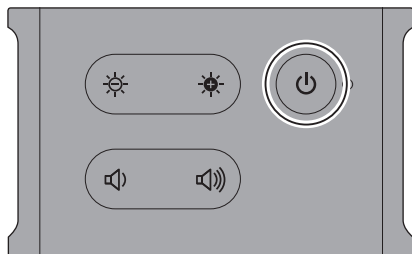

While viewing an image, you can hide the images and mute the audio by pressing the [⏻] button (AV Mute).

Press the [⏻] button again to release AV mute and resume the images and audio.

To turn off the product, disconnect the power supply source.



See the following for information on using the buttons.

➔ **"Interface Box" p.10**

➔ **"Extended Features" p.18**



- When playing a movie, the movie continues to playback even though images are hidden and audio is muted in standby mode or AV mute. To stop the movie, you need to stop it on the external device.

- This product is not rechargeable. You need to connect equipment that can supply enough power.

➔ **"Connecting by HDMI" p.13**

➔ **"Connecting by USB Type-C" p.14**

Standby Mode and AV Mute

Although standby mode and AV mute will hide the images and mute the audio, there are a few differences.

Select the appropriate mode to suit your needs.

	Setting	Time to Display Images	Power Consumed
Standby mode	Hold down the [⏻] button	Long (approx. 8 secs.)	Low power consumption
AV mute	Briefly press the [⏻] button	Short	More than in standby mode



This product automatically switches to standby mode (in mode 1 only) after 20 minutes of inactivity or after 20 minutes if AV mute is enabled.

➔ **"Extended Features" p.18**

Extended Features

You can access extended features by holding down two buttons at the same time.

You can check the status of the extended features in the display or by using the LED indicators.

Switching between 2D and 3D display

This product uses the side-by-side 3D display format.

To switch between 2D and 3D mode, hold down the [☀] and the [🔊] keys at the same time.

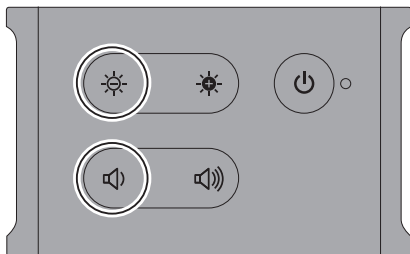

The following is shown on the display when switching modes.



Adjusting the screen brightness automatically

This product can automatically adjust the brightness of the screen according to the brightness of the environment in which it is being used.

To turn auto brightness adjustment on or off, hold down the [☀] and the [🔊] keys at the same time.

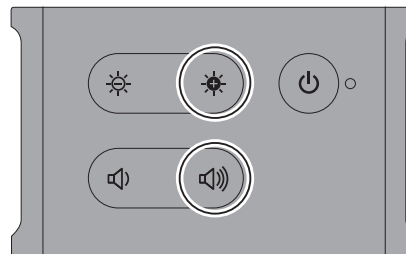

The following is shown on the display when switching modes.



Changing the mode setting

The following three modes are available. To switch the mode, hold down the [] key and the [] button at the same time.

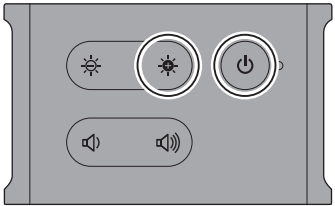

	Power saving feature*1	[] button*2	When switching mode	
			LED indicator*3	Display
Mode 1 (Default setting)	Enabled	Operations available	Flashes white once	Auto :ON
Mode 2	Disabled	Operations available	Flashes white twice	Auto :OFF
Mode 3	Disabled	Operations unavailable	Flashes white three times	Auto :OFF

*1 This feature automatically switches to standby mode after 20 minutes of inactivity when no image is being input, or after 20 minutes when AV mute is enabled.

*2 The [] button shows/hides images. Hold down to switch to standby mode.

➔ "Standby Mode and AV Mute" p.17

*3 You can check the mode by the number of times the LED flashes white immediately after making settings.

In Mode 3, the [] button is disabled which helps to avoid operation mistakes when you want to show the display at all times.

Wearing the Headset

- 1 Use both hands to open the temples, and then put on the headset.



! Do not use too much force when opening the temples of the headset.

- 2 Adjust the position of the headset so that you can see the image.

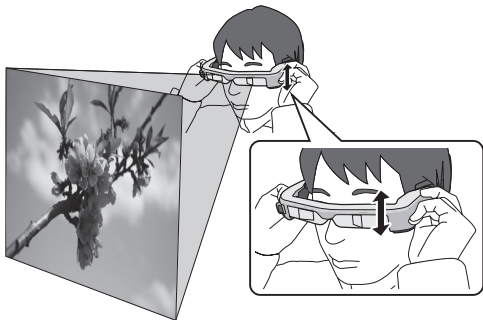

- How an image is perceived varies depending on the individual.
- You can connect the earphone microphone to the earphone microphone socket. Use earphones that conform to the CTIA standard. You may hear some noise if the earphone microphone or other cables are disconnected or connected while content is being played.



You can clip the earphone microphone to your clothes.



Make sure the cable does not catch on anything in the surrounding area while wearing the product. Also, make sure the cable does not wind around your neck.

Wearing over Glasses

The headset can be worn over glasses. (The headset can only be worn over glasses that are approximately 147 mm wide.)



- Make sure that you do not damage the glasses and the lens of the headset when wearing.
- You may not be able to wear the headset over the glasses depending on the shape of your glasses.

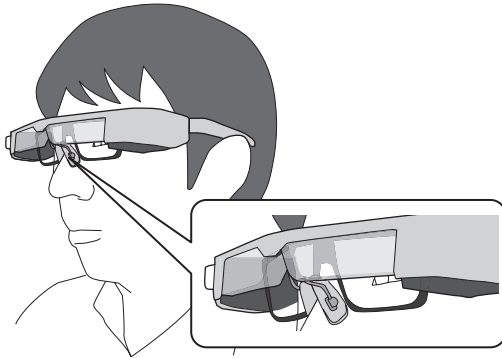

The nose pads fit over your glasses.

Using the Shade

If the surrounding ambient light is too bright to view the screen when wearing the headset, attach the shade.

➔ **"Attaching and Removing the Shade" p.24**

When the shade is unnecessary, leave it flipped up.

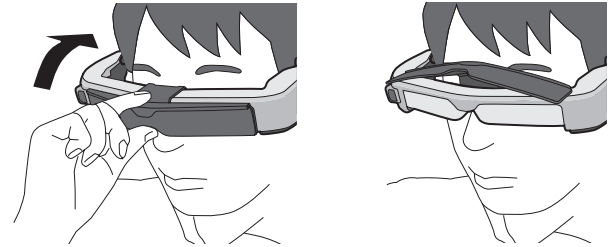

You can adjust the brightness of the screen by using the [☀️ / 🌑] keys.

➔ **"Interface Box" p.10**

Using the Belt Clip/Cable Retainer

You can attach the interface box to the belt by using a belt clip or cable retainer.

You can also secure extra cables to the cable retainer by using a commercially available band and so on.

- 1 Attach the belt clip to the interface box using the screw supplied.**

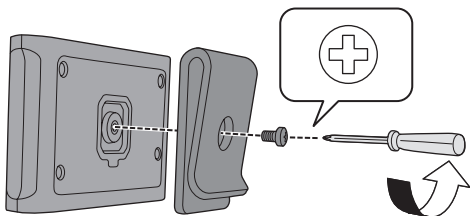

By changing the direction of the belt clip you can rotate the interface box by 90 degrees.



- 2 Connect the cable.**

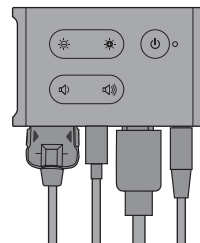

- 3 Attach the clip to a belt and so on.**

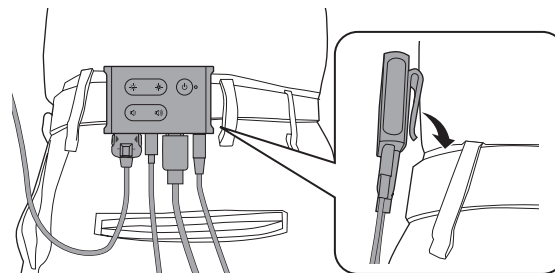



Use the same procedure to attach the cable retainer to the belt. You can secure other cables using commercially available bands and so on so that they do not catch on anything in the surrounding area.

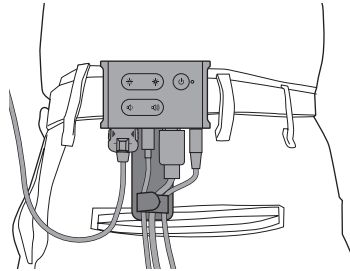

Caution

- Keep the cables as close to your body as possible. Sagging cables may cause accidents or injuries if they become caught or trapped by surrounding objects.
- Do not pull the headset's cable. If the headset comes off, it may result in accident or injury.

Replacing the Parts

Attaching and Removing the Shade



When replacing the shade, make sure you purchase the option for the BT-350.

■ Attaching the shade

Hold the shade at an angle and press it against the protruding sections (two points) at the center of the headset.

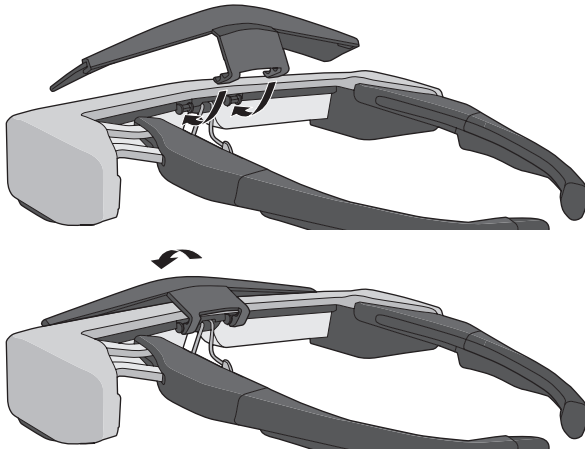

■ Removing the shade

To remove the shade, flip it up, and then push down and pull it towards you.

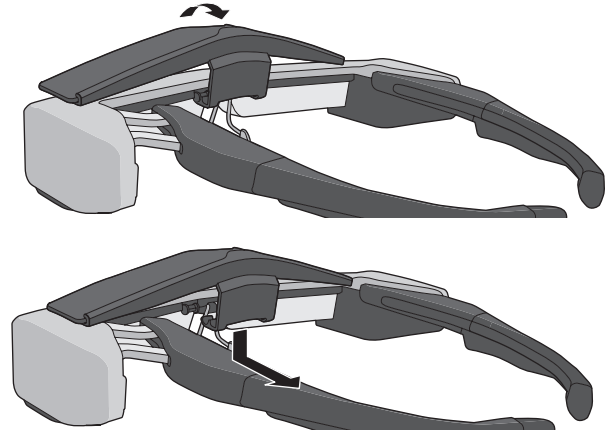

If the shade is pushed or pulled with too much force, the shade and the lens could be damaged. Do not use too much force on the shade.

Replacing the Temple Grip



When replacing the temple grips, make sure you purchase the option for the BT-350.

- 1 Press the part indicated by the circle (○) and remove the tip of the temple grip.

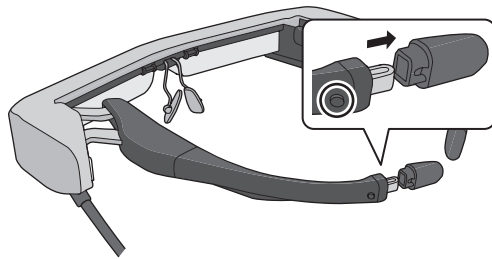

- 2 Slide off the remaining temple grip.

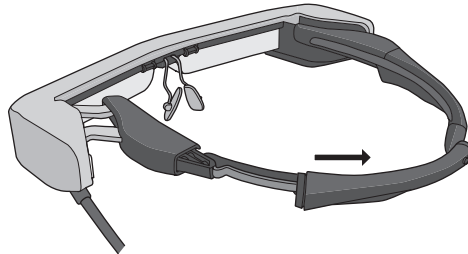

- 3 Slide the replacement temple grip into the groove in the headset.

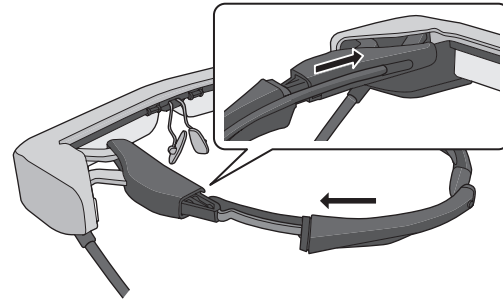

- 4 While pressing the part indicated by the circle (○), attach the tip of the temple grip.

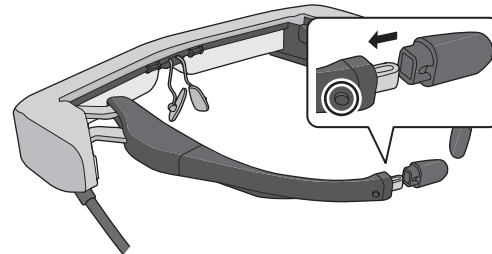

Replacing the Nose Pads

 When replacing the nose pads, make sure you purchase the option for the BT-350.

- 1 Pull the nose pads towards you to remove them.**

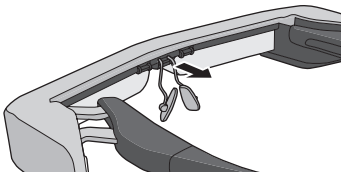

- 2 Attach the nose pads.**

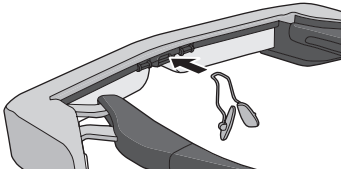

Supported Equipment and Software

External device

HDMI® display	Supported equipment	Video output equipment with HDMI ports
	Resolution (frame rate)	1920 x 1080 (60 Hz/59.94 Hz), 1280 x 720 (60 Hz/59.94 Hz), 1280 x 720 (30Hz), 640 x 480 (60 Hz)
DisplayPort display	Supported equipment	Computers and smart devices with USB Type-C ports that support DisplayPort Alternate Mode on USB Type-C ^{*1}
	Resolution (frame rate)	1920 x 1080 (60 Hz/59.94 Hz), 1280 x 720 (60 Hz/59.94 Hz), 1280 x 720 (30Hz), 640 x 480 (60 Hz)

*1 HDMI data transfer is not supported.

Images may not be displayed correctly at other resolutions.

Sensors and camera

Supported equipment	Computers and smart devices with USB Type-C ports
Supported operating systems	Windows 10 and Android™ OS Ver. 7.0 or later

When using the headset's sensors or camera, you need to install a sensor or camera-enabled application on the external device that you want to connect to.

The camera function for this product conforms to UVC1.1.

Software development kit

You need a dedicated SDK (Software Development Kit) to control the sensor, camera, and display from your application.

See the Developer's Guide (<https://tech.moverio.epson.com/en/bt-35e/document.html>) for more information.

Updating the Firmware

Download the firmware to your computer from the following download site, and then update it using the Epson BT-35E Update Tool.

See the firmware release notes for more information.

<https://tech.moverio.epson.com/en/bt-35e/download.html>

Maintenance

Cleaning the headset

- If you can see marks in the image or if the image is hazy, check that there is no dirt, dust, fingerprints, and so on, on the lenses.

If there is dust or dirt on the lenses, wipe them carefully with a soft cloth.



When wiping the lenses, do not use lens cleaning liquids or organic solvents.

- If the camera is dirty, wipe it carefully with a soft cloth.
- If any parts other than the lens or camera are dirty, wipe them with a wet tissue.

Storing the headset

- When storing the headset, place it in the packaging that it came in or the dedicated carrying case.
- When placing the headset, make sure it is placed horizontally so that it does not touch against hard objects. If the headset is placed with the lens facing down and the lens touches hard objects, the lens could be damaged.

Cleaning the connector ports

- If the connectors on the interface box are dirty or if there are foreign objects stuck to them, they may not work correctly. Wipe away any dirt with a dry cloth or cotton swab at least once every three months.



Caution

- Do not damage the connector ports with your finger or a hard object.
- Do not expose the connector ports to water. When cleaning the connector ports, use a dry cloth or a cotton swab.

Troubleshooting

If you think a malfunction has occurred, check the following.

No image is displayed

- Check if any cables are disconnected.
- If the LED indicator flashes orange for more than three seconds, an error has occurred.

➔ "Part Names and Functions" p.10

Unplug the dedicated USB power supply cable or the USB Type-C cable that is supplying the power, wait for a while, and then reconnect.

- If images are not displayed by a USB Type-C connection, check that the connected equipment supports video output by USB Type-C. This product supports DisplayPort Alternate mode (DP ALT mode) for USB Type-C.

Images are fuzzy

- Reconnect the cables.
- Restart the connected equipment.

The display is not hidden when you press the [⏻] button

The product may be set to Mode 3 in extended features. Hold down the [☀️] key and the [⏻] button at the same time to set Mode 1 or Mode 2.

➔ "Extended Features" p.18



Cannot hear audio

- Check that the earphones are connected securely.
- Check that the volume is set correctly.
- Check that audio is being output from the output equipment.
- You may not be able to use it depending on the type of standard earphone microphone you are using such as earphone microphones with a switch.

Cannot adjust the brightness of the screen

- If the product gets too hot, the image brightness may be decreased to protect the product.

You can check if the brightness has been limited by pressing the [☀️ / ☀️] keys.

Normal operation	Brightness limited
 10	 10

Specifications

Product Specifications

Model Number	BT-35E (H935A)	
Material	Si-OLED	
Panel size	0.43" wide panel (16:9)	
Resolution	1280x720	
Angle of view	Approximately 23 degrees (diagonally)	
Virtual screen size	40" support (virtual viewing distance 2.5 m)	
Color reproduction	24 bit color (approximately 16,770,000 colors)	
Supported 3D	Side-by-side format	
Connector ports	Interface box connector ports, 4 pin mini jack (earphones with microphone complying with the CTIA standard)*1, USB Type-C, HDMI, USB Micro-B (power supply only)	
Operating temperature	5 to 35°C humidity 20 to 80% (no condensation)	
Storage temperature	-10 to 60°C humidity 20 to 80% (no condensation)	
AC adapter	Model Number	PSAF10R-050Q
	Manufacturer	PHIHONG TECHNOLOGY CO., LTD.
	Rated output voltage/current	5 V/2 A
Exterior dimensions (W x D x H)	Headset	193.5 x 176 x 30 mm (without the shade)
	Interface box	85 x 52 x 15 mm
Mass	Headset	Approx. 119 g (without shade and cables)
	Interface box	Approx. 45 g
Camera	5 million pixels (Pan focus)	
Earphone output	Max. voltage	150 mV or less
	Voltage with broadband characteristics	75 mV or more
Sensors	geomagnetic sensor/accelerometer sensor/gyroscopic sensor/ambient light sensor	

*1 Restrictions in operation may occur when using an adapter plug.

Video Input

HDMI (Type A)	HDMI	Ver. 1.4
	Resolution (frame rate)	1920 x 1080 (60 Hz/59.94 Hz), 1280 x 720 (60 Hz/59.94 Hz), 1280 x 720 (30Hz), 640 x 480 (60 Hz)
	EDID	Supported
	CEC	Not supported
	HDCP	Rev. 1.4
	3D formats	Not supported
	HDMI Data Transfer	Not supported
USB Type-C	Video interface	DisplayPort Alternate Mode (DP Alt Mode)
	Resolution (frame rate)	1920 x 1080 (60 Hz/59.94 Hz), 1280 x 720 (60 Hz/59.94 Hz), 1280 x 720 (30Hz), 640 x 480 (60 Hz)
	EDID	Supported
	HDCP	Rev. 1.3

Power

Interface	USB Type-C	USB Type-C Current @ 1.5 A
	USB Micro-B	5.0V/1.5 A (DC input)
Electricity consumption	Operating: Approx. 6.5 W Standby power consumption (Communication On): 2.0 W Standby power consumption (Communication Off): 0.3 W	

Intellectual Property Rights

.....
Notations In this guide, the Microsoft® Windows® 10 operating system is referred to as "Windows 10".
.....

.....
Trademarks "EPSON" is a registered trademark of the Seiko Epson Corporation. "EXCEED YOUR VISION" is a registered trademark or a trademark of the Seiko Epson Corporation.
Windows is a registered trademark of the Microsoft Corporation in the USA and other countries.
HDMI and High-Definition Multimedia Interface are the trademarks or registered trademarks of HDMI Licensing LLC.  **HDMI**[™]
HIGH DEFINITION MULTIMEDIA INTERFACE
USB Type-C[™] is a trademark of the USB Implementers Forum.
Android[™] is a trademark of Google LLC.
Other product names used herein are also for identification purposes only and may be trademarks of their respective owners. Epson disclaims any and all rights in those marks.
.....

General Notes

Restriction of Use

This product is manufactured based on the specifications of the country of sale. When using this product outside the country of sale, contact your nearest support center.

When this product is used for applications requiring high reliability/safety such as transportation devices related to aviation, rail, marine, automotive; disaster prevention devices; various safety devices; or functional/precision devices, you should use this product only after giving consideration to including fail-safes and redundancies into your design to maintain safety and total system reliability.

Because this product was not intended for use in applications requiring extremely high reliability/safety such as aerospace equipment, main communication equipment, nuclear power control equipment, or medical equipment related to direct medical care, please make your own judgment on this product's suitability after a full evaluation.

Authentication information

U.S.A./Canada



Europe



Supplier's DECLARATION of CONFORMITY

According to 47CFR, Part 2 and 15
Class B Personal Computers and Peripherals; and/or
CPU Boards and Power Supplies used with Class B Personal Computers

We : Epson America, Inc.

Located at : 3840 Kilroy Airport Way MS : 3-13 Long Beach, CA 90806

Tel : 562-981-3840

Declare under sole responsibility that the product identified herein, complies with 47CFR Part 2 and 15 of the FCC rules as a Class B digital device. Each product marketed, is identical to the representative unit tested and found to be compliant with the standards. Records maintained continue to reflect the equipment being produced can be expected to be within the variation accepted, due to quantity production and testing on a statistical basis as required by 47CFR 2.909.

Trade Name : EPSON

Type of Product : Smart Glasses

Model : H935A

FCC Compliance Statement

This equipment has been tested and found to comply with the limits for a Class B digital device, pursuant to Part 15 of the FCC Rules. These limits are designed to provide reasonable protection against harmful interference in a residential installation. This equipment generates, uses, and can radiate radio frequency energy and, if not installed and used in accordance with the instructions, may cause harmful interference to radio communications. However, there is no guarantee that interference will not occur in a particular installation. If this equipment does cause harmful interference to radio or television reception, which can be determined by turning the equipment off and on, the user is encouraged to try to correct the interference by one or more of the following measures.

- Reorient or relocate the receiving antenna.
- Increase the separation between the equipment and receiver.
- Connect the equipment into an outlet on a circuit different from that to which the receiver is connected.
- Consult the dealer or an experienced radio/TV technician for help.
- Operation is subject to the following two conditions: (1) this device may not cause harmful interference, and (2) this device must accept any interference received, including interference that may cause undesired operation.

WARNING

The connection of a non-shielded equipment interface cable to this equipment will invalidate the FCC Certification or Declaration of this device and may cause interference levels which exceed the limits established by the FCC for this equipment. It is the responsibility of the user to obtain and use a shielded equipment interface cable with this device. If this equipment has more than one interface connector, do not leave cables connected to unused interfaces. Changes or modifications not expressly approved by the manufacturer could void the user's authority to operate the equipment.

Canada

CAN ICES-3 (B)/NMB-3(B)

This Class B digital apparatus complies with Canadian ICES-003.
Cet appareil numérique de la classe B est conforme à la norme NMB-003 du Canada.





Indication of the manufacturer and the importer in accordance with requirements of EU directive





Manufacturer: SEIKO EPSON CORPORATION
Address: 3-5, Owa 3-chome, Suwa-shi, Nagano-ken 392-8502 Japan
Telephone: 81-266-52-3131
<http://www.epson.com/>



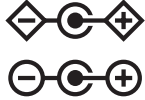

Importer: EPSON EUROPE B.V.
Address: Atlas Arena, Asia Building Hoogoorddreef 5, 1101 BA Amsterdam Zuidooost
The Netherlands
Telephone: 31-20-314-5000
<http://www.epson.eu/>

List of Safety Symbols

The following table lists the meaning of the safety symbols labeled on the equipment.

No.	Symbol mark	Approved standards	Meaning
1		IEC60417 No. 5007	"ON" (power) To indicate connection to the mains.
2		IEC60417 No. 5008	"OFF" (power) To indicate disconnection from the mains.
3		IEC60417 No. 5009	Stand-by To identify the switch or switch position by means of which part of the equipment is switched on in order to bring it into the stand-by condition.
4		ISO7000 No. 0434B IEC3864-B3.1	Caution To identify general caution when using the product.
5		IEC60417 No. 6042 ISO3864-B3.6	Caution, risk of electric shock To identify equipment that has risk of electric shock.

No.	Symbol mark	Approved standards	Meaning
6		IEC60417 No. 5957	For indoor use only To identify electrical equipment designed primarily for indoor use.
7		IEC60417 No. 5926	Polarity of d.c. power connector To identify the positive and negative connections (the polarity) on a piece of equipment to which a d.c. power supply may be connected.
8		IEC60417 No. 5017	Earth To identify an earth (ground) terminal.
9		IEC60417 No. 5032	Alternating current To indicate on the rating plate that the equipment is suitable for alternating current only; to identify relevant terminals.
10		IEC60417 No. 5031	Direct current To indicate on the rating plate that the equipment is suitable for direct current only; to identify relevant terminals.

No.	Symbol mark	Approved standards	Meaning
11		IEC60417 No. 5172	Class II equipment To identify equipment meeting the safety requirements specified for Class II equipment according to IEC 61140.
12		ISO 3864	General prohibition To identify actions or operations that are prohibited.
13		ISO 3864	Contact prohibition To indicate injury that could occur due to touching a specific part of the equipment.
14		IEC60417 No. 5266	Standby, partial standby To indicate that part of the equipment is in the ready status.

Contact List

This address list is current as of May 2018.

A more up-to-date contact address can be obtained from the corresponding website listed here. If you do not find what you need on any of these pages, please visit the main Epson home page at www.epson.com.

EUROPE, MIDDLE EAST & AFRICA

ALBANIA

ITD Sh.p.k.

<http://www.itd-al.com>

AUSTRIA

Epson Deutschland GmbH

<http://www.epson.at>

BELGIUM

Epson Europe B.V.

Branch office Belgium

<http://www.epson.be>

BOSNIA AND HERZEGOVINA

NET d.o.o. Computer Engineering

<http://www.net.com.ba>

BULGARIA

Epson Service Center Bulgaria

<http://www.kolbis.com>

CROATIA

MR servis d.o.o.

<http://www.mrservis.hr>

CYPRUS

Mechatronic Ltd.

<http://www.mechatronic.com.cy>

CZECH REPUBLIC

Epson Europe B.V.

Branch Office Czech Republic

<http://www.epson.cz>

DENMARK

Epson Denmark

<http://www.epson.dk>

ESTONIA

Epson Service Center Estonia

<http://www.epson.ee>

FINLAND

Epson Finland

<http://www.epson.fi>

FRANCE & DOM-TOM TERRITORY

Epson France S.A.

<http://www.epson.fr>

GERMANY

Epson Deutschland GmbH

<http://www.epson.de>

GREECE

Oktabit S.A.

<http://www.oktabit.gr>

HUNGARY

Epson Europe B.V.

Branch Office Hungary

<http://www.epson.hu>

IRELAND

Epson (UK) Ltd.

<http://www.epson.ie>

ISRAEL

Epson Israel
<http://www.epson.co.il>

ITALY

Epson Italia s.p.a.
<http://www.epson.it>

KAZAKHSTAN

Epson Kazakhstan Rep. Office
<http://www.epson.kz>

LATVIA

Epson Service Center Latvia
<http://www.epson.lv>

LITHUANIA

Epson Service Center Lithuania
<http://www.epson.lt>

LUXEMBURG

Epson Europe B.V.
Branch office Belgium
<http://www.epson.be>

MACEDONIA

Digit Computer Engineering
<http://www.digit.com.mk>

NETHERLANDS

Epson Europe B.V.
Benelux sales office
<http://www.epson.nl>

NORWAY

Epson Norway
<http://www.epson.no>

POLAND

Epson Europe B.V.
Branch Office Poland
<http://www.epson.pl>

PORTUGAL

Epson Ibérica S.A.U.
Branch Office Portugal
<http://www.epson.pt>

ROMANIA

Epson Europe B.V.
Branch Office Romania
<http://www.epson.ro>

RUSSIA

Epson CIS
<http://www.epson.ru>

UKRAINE

Epson Kiev Rep. Office
<http://www.epson.ua>

SERBIA

Atom partner
<http://www.atompartner.rs/wp/>
EWE Comp
<http://www.ewe.rs>

SLOVAKIA

Epson Europe B.V.
Branch Office Czech Republic
<http://www.epson.sk>

SLOVENIA

Birotehna d.o.o.
<http://www.birotehna.si>

SPAIN

Epson Ibérica, S.A.U.
<http://www.epson.es>

SWEDEN

Epson Sweden
<http://www.epson.se>

SWITZERLAND

Epson Deutschland GmbH
Branch office Switzerland
<http://www.epson.ch>

TURKEY

Tecpro Bilgi Teknolojileri Tic. ve
San. Ltd. Sti.
<http://www.tecpro.com.tr>

UK

Epson (UK) Ltd.
<http://www.epson.co.uk>

AFRICA

<http://www.epson.co.za>
or
<http://www.epson.fr>

SOUTH AFRICA

Epson South Africa
<http://www.epson.co.za>

MIDDLE EAST

Epson (Middle East)
<http://www.epson.ae>

NORTH, CENTRAL AMERICA & CARIBBEAN ISLANDS

CANADA

Epson Canada, Ltd.
<http://www.epson.ca>

COSTA RICA

Epson Costa Rica, S.A.
<http://www.epson.co.cr>

MEXICO

Epson Mexico, S.A. de C.V.
<http://www.epson.com.mx>

ECUADOR

Epson Ecuador
<http://www.epson.com.ec>

U. S. A.

Epson America, Inc.
<http://www.epson.com>

SOUTH AMERICA

ARGENTINA

Epson Argentina S.R.L.
<http://www.epson.com.ar>

BRAZIL

Epson do Brasil
<http://www.epson.com.br>

CHILE

Epson Chile S.A.
<http://www.epson.cl>

COLOMBIA

Epson Colombia Ltd.
<http://www.epson.com.co>

PERU

Epson Peru S.A.
<http://www.epson.com.pe>

VENEZUELA

Epson Venezuela S.A.
<http://www.epson.com.ve>

ASIA & OCEANIA

AUSTRALIA

Epson Australia Pty. Ltd.
<http://www.epson.com.au>

CHINA

Epson (China) Co., Ltd.
<http://www.epson.com.cn>

HONG KONG

Epson Hong Kong Ltd.
<http://www.epson.com.hk>

INDIA

Epson India Pvt., Ltd.
<http://www.epson.co.in>

INDONESIA

PT. Epson Indonesia
<http://www.epson.co.id>

JAPAN

Seiko Epson Co.
Toyoshina Plant
<http://www.epson.jp>

KOREA

Epson Korea Co., Ltd.
<http://www.epson.co.kr>

MALAYSIA

Epson Malaysia Sdn. Bhd.
<http://www.epson.com.my>

NEW ZEALAND

Epson New Zealand
<http://www.epson.co.nz>

PHILIPPINES

Epson Philippines Co.
<http://www.epson.com.ph>

SINGAPORE

Epson Singapore Pte. Ltd.
<http://www.epson.com.sg>

TAIWAN

Epson Taiwan Technology & Trading Ltd.
<http://www.epson.com.tw>

THAILAND

Epson (Thailand) Co.,Ltd.
<http://www.epson.co.th>
