FPC-5210 Series

Robust Box PC with Intel® 12th/13th Gen Alder
Lake
supporting Nvidia® MXM3.1 GPU

User's Manual

Version 1.0



This page is intentionally left blank.

Revision History

Version	Release Time	Description
1.0	2023.07	Initial release

Revision History	i
Contents	ii
Preface.....	v
Copyright Notice.....	v
Declaration of Conformity.....	v
CE	v
FCC Class A.....	v
RoHS.....	vi
SVHC / REACH.....	vi
Important Safety Instructions	vii
Warning.....	viii
Replacing Lithium Battery	viii
Technical Support.....	viii
Warranty.....	ix
Chapter 1 - Introduction.....	1
1.1. The Computer	2
1.2. About this Manual.....	2
1.3. Specifications	2
1.4. Inside the Package.....	5
1.4.1. Optional Accessories	5
1.4.2. Optional Configuration (CTOS* Kit)	6
Chapter 2 - System Overview	9
2.1. Dimensions	10
2.2. Take A Tour.....	11
2.2.1. Front View	11
2.2.2. FPC-5210-P6 Rear View.....	11
2.3. Driver Installation Notes	12
Chapter 3 - System Configuration	13
3.1. Board Layout.....	14
3.2. Pinheaders and Connectors.....	17
Chapter 4 - Installation and Maintenance.....	29
4.1. Install Hardware	30
4.1.1. Open the Computer.....	30
4.1.2. Install CPU	33
4.1.3. Install/Uninstall Memory Modules	34
4.1.4. Installing M.2 Storage Module.....	38
4.1.5. Install Wi-Fi Module.....	39
4.1.5. Install Internal SATA Storage Device	44
4.1.6. Install MXM3.1 TYPE A/B GPU Cards	45
4.2. Wire DC-in Power Source.....	48

4.2.1 Automation Mode	48
4.2.2 Vehicle Application Mode	49
Chapter 5 - BIOS	51
5.1. Main	54
5.2. Advanced	55
5.2.1. CPU Configuration	57
5.2.2. Power & Performance	58
5.2.3. Trusted Computing	60
5.2.4. ACPI Settings	61
5.2.5. Smart Settings	62
5.2.6. F81966 Super IO Configuration	63
5.2.7. Hardware Monitor	64
5.2.8. S5 RTC Wake Settings	65
5.2.11. USB Configuration	69
5.2.12. Network Stack Configuration	71
5.2.13. NVME Configuration	72
5.3. Chipset	73
5.2.9. Serial Port Console Redirection	66
5.2.10. AMI Graphic Output Protocol Policy	68
5.5. Boot	79
5.6. Save & Exit	81
5.7. MEBx	81

This page is intentionally left blank.

Copyright Notice

All Rights Reserved.

The information in this document is subject to change without prior notice in order to improve the reliability, design and function. It does not represent a commitment on the part of the manufacturer.

Under no circumstances will the manufacturer be liable for any direct, indirect, special, incidental, or consequential damages arising from the use or inability to use the product or documentation, even if advised of the possibility of such damages.

This document contains proprietary information protected by copyright. All rights are reserved. No part of this document may be reproduced by any mechanical, electronic, or other means in any form without prior written permission of the manufacturer.

Declaration of Conformity

CE

The CE symbol on the computer indicates that it is in compliance with the directives of the Union European (EU). A Certificate of Compliance is available by contacting Technical Support.

This product has passed the CE test for environmental specifications when shielded cables are used for external wiring. We recommend the use of shielded cables. This kind of cable is available from ARBOR. Please contact your local supplier for ordering information.

Warning

This is a class A product. In a domestic environment this product may cause radio interference in which case the user may be required to take adequate measures.

FCC Class A

This device complies with Part 15 of the FCC Rules. Operation is subject to the following two conditions:

- (1) This device may not cause harmful interference, and
- (2) This device must accept any interference received, including interference that may cause undesired operation.

NOTE:

This equipment has been tested and found to comply with the limits for a Class A digital device, pursuant to Part 15 of the FCC Rules. These limits are designed to provide reasonable protection against harmful interference when the equipment is operated in a commercial environment. This equipment generates, uses, and can radiate radio frequency energy and, if not installed and used in accordance with the instruction manual, may cause harmful interference to radio communications. Operation of this equipment in a residential area is likely to cause harmful interference in which case the user will be required to correct the interference at his own expense.

RoHS

ARBOR Technology Corp. certifies that all components in its products are in compliance and conform to the European Union's Restriction of Use of Hazardous Substances in Electrical and Electronic Equipment (RoHS) Directive 2002/95/EC.

The above mentioned directive was published on 2/13/2003. The main purpose of the directive is to prohibit the use of lead, mercury, cadmium, hexavalent chromium, polybrominated biphenyls (PBB), and polybrominated diphenyl ethers (PBDE) in electrical and electronic products. Member states of the EU are to enforce by 7/1/2006.

ARBOR Technology Corp. hereby states that the listed products do not contain unintentional additions of lead, mercury, hex chrome, PBB or PBDB that exceed a maximum concentration value of 0.1% by weight or for cadmium exceed 0.01% by weight, per homogenous material. Homogenous material is defined as a substance or mixture of substances with uniform composition (such as solders, resins, plating, etc.). Lead-free solder is used for all terminations (Sn(96-96.5%), Ag(3.0-3.5%) and Cu(0.5%)).

SVHC / REACH

To minimize the environmental impact and take more responsibility to the earth we live, Arbor hereby confirms all products comply with the restriction of SVHC (Substances of Very High Concern) in (EC) 1907/2006 (REACH --Registration, Evaluation, Authorization, and Restriction of Chemicals) regulated by the European Union.

All substances listed in SVHC < 0.1 % by weight (1000 ppm)

Important Safety Instructions

Read these safety instructions carefully

1. Read all cautions and warnings on the equipment.
2. Place this equipment on a reliable surface when installing. Dropping it or letting it fall may cause damage
3. Make sure the correct voltage is connected to the equipment.
4. For pluggable equipment, the socket outlet should be near the equipment and should be easily accessible.
5. Keep this equipment away from humidity.
6. The openings on the enclosure are for air convection and protect the equipment from overheating. **DO NOT COVER THE OPENINGS.**
7. Position the power cord so that people cannot step on it. Do not place anything over the power cord.
8. Never pour any liquid into opening. This may cause fire or electrical shock.
9. Never open the equipment. For safety reasons, the equipment should be opened only by qualified service personnel.
10. If one of the following situations arises, get the equipment checked by service personnel:
 - a. The power cord or plug is damaged.
 - b. Liquid has penetrated into the equipment.
 - c. The equipment has been exposed to moisture.
 - d. The equipment does not work well, or you cannot get it to work according to the user's manual.
 - e. The equipment has been dropped or damaged.
 - f. The equipment has obvious signs of breakage.
11. Keep this User's Manual for later reference.

Warning

The Box PC and its components contain very delicately Integrated Circuits (IC). To protect the Box PC and its components against damage caused by static electricity, you should always follow the precautions below when handling it:

1. Disconnect your Box PC from the power source when you want to work on the inside.
2. Use a grounded wrist strap when handling computer components.
3. Place components on a grounded antistatic pad or on the bag that came with the Box PC, whenever components are separated from the system.

Replacing Lithium Battery

Incorrect replacement of the lithium battery may lead to a risk of explosion.

The lithium battery must be replaced with an identical battery or a battery type recommended by the manufacturer.

Do not throw lithium batteries into the trash can. It must be disposed of in accordance with local regulations concerning special waste.

Technical Support

If you have any technical difficulties, please consult the user's manual first at:
<http://www.arbor-technology.com>

Please do not hesitate to e-mail our customer service when you still cannot find out the answer.

E-mail: info@arbor.com.tw

Warranty

This product is warranted to be in good working order for a period of one year from the date of purchase. Should this product fail to be in good working order at any time during this period, we will, at our option, replace or repair it at no additional charge except as set forth in the following terms. This warranty does not apply to products damaged by misuse, modifications, accident or disaster.

Vendor assumes no liability for any damages, lost profits, lost savings or any other incidental or consequential damage resulting from the use, misuse of, or inability to use this product. Vendor will not be liable for any claim made by any other related party.

Vendors disclaim all other warranties, either expressed or implied, including but not limited to implied warranties of merchantability and fitness for a particular purpose, with respect to the hardware, the accompanying product's manual(s) and written materials, and any accompanying hardware. This limited warranty gives you specific legal rights.

Return authorization must be obtained from the vendor before returned merchandise will be accepted. Authorization can be obtained by calling or faxing the vendor and requesting a Return Merchandise Authorization (RMA) number. Returned goods should always be accompanied by a clear problem description.

This page is intentionally left blank.

Chapter 1

Introduction

1.1. The Computer

FPC-5210-P6

- SMART FAN support
- 12th /13th Generation Core™ i9/i7/i5/i3 Processor (Alder Lake-S)
- Support up to 120W GPU MXM module expansion
- 6 x 802.3af (15.4W) Gigabit PoE ports
- Wide range DC power input (9~36V)
- DP x2 + HDMI x 1 and DVI x 1 (support 4 independent displays)
- Power on/off delay control / configurable ignition power control
- Supports TPM 2.0 and Time-Sensitive Networking (TSN)
- Two-mPCIe for optional WiFi/3G/4G/GPS or I/O expansion supported
- 1 x M.2 B-Key for storage or 5G / LTE +1 x M.2 E-Key for WiFi / BT
- 1 x M.2 M-Key for NVMe SSD
- 6 x RJ-45 connectors by Intel® I210(1GbE) max 60W supports 802.3af POE

1.2. About this Manual

This manual is meant for the experienced users and integrators with hardware knowledge of personal computers. If you are not sure about the description herein, consult your vendor before further handling.

We recommend that you keep one copy of this manual for the quick reference for any necessary maintenance in the future. Thank you for choosing ARBOR products.

1.3. Specifications

FPC-5210-P6

System	
CPU	Intel® 12 th /13 th generation Core™ i9/i7/i5/i3 processor in LGA1700 socket (Max 65W CPU)
Memory	2 x 262-pin DDR5 SO-DIMM sockets, supporting 4800 MHz SDRAM up to 64GB (ECC/ Non-ECC)
Chipset	Intel® R680E

Graphics	Integrated Intel® HD Graphics 770
ATA	2 x Serial ATA ports with 600MB/s HDD transfer rate
LAN Chipset	1 x Intel® I219LM GbE controller w/ iAMT 16.0 1 x Intel® I226 2.5G GbE controllers 6 x Intel® I210 GbE controllers for PoE
Watchdog Timer	1~255 levels reset
TPM	Infineon SLB9670 supports TPM 2.0
I/O	
Serial Port	2 x RS-232/422/485 configurable ports via DB-9 connectors (Default RS232, Switch via BIOS)
USB Port	8 x USB 3.2 Gen2 ports
LAN	4 x RJ-45 connectors for GbE 6 x RJ-45 connectors by Intel® I210(1GbE) max 60W supports 802.3af POE
Video Port	2 x DP 1.4a from MXM module or Intel Graphics
	1 x HDMI 2.0b female connector
	1 x DVI-I female connector for digital / analog video output *Support 4 independent displays
Digital I/O Port	1 x DB15 connector for 8 x digital input (Dry/ Wet contact) with 2KV isolation
	1 x DB15 connector for 8 x digital output with 2KV isolation
Audio	Mic-in/Line-out
Expansion Bus	1 x MXM3.1 TYPE A/B GPU Slot (PCIe Gen5 x16) MXM A4500 Support
	2 x mini-PCI Express Slots interconnected with SIM card sockets for optional WiFi/BT/3G/LTE/ GPS (PCIex1+USB2.0, Full Size)
	3 x SIM socket (2 for mPCIe / 1 for M.2 B key)
	1 x M.2 B key (2242/3052/2280) w/ (PCIex2+USB3.0+SATA) interconnected with SIM for 5G / LTE or for storage (either one) 1 x M.2 E key (2230) with PCIex1+USB2.0+CNVi) for Wireless
Environmental	
Operating Temp.	-20 ~ 55°C (-4 ~ 131°F), (w/ 65W TDP CPU,115W GPU)
Storage Temp.	-40 ~ 85°C (-40 ~ 185°F)
Operating Humidity	10 ~ 95% @ 55°C (non-condensing)
Vibration	5~500Hz 2G rms X,Y,Z axis w/SSD, according to IEC 60068-2-64

Introduction

Shock	30 Grms, Half-sine 11 m sec. duration w/ SSD, according IEC60068-2-27
Qualification	
Certification	CE, FCC Class A
Power Requirement	
Main Power Input	DC 9~36V input (w/ 4-pin DC input terminal block) (V+ ,V+, V-, V-)
Ignition Switch	2-pin terminal block: IGN, GND (9~36V)
Power Consumption	Max. 280W
Storage	
Type	2 x 2.5" outside accessible drive bays
	1 x M.2 B key (2242/2280) w/ (PCIex2+USB+ SATA) for storage or LTE expansion (either one)
	1 x M.2 2280 M key supports 2242,2280 devices (PCIe x4 & SATA signal, support boot up function)
Mechanical	
Construction	Metal
Mounting	Wall-mount
Weight	4.68 Kg (10.32lb)
Dimensions (W x D x H)	285 x 230 x 110mm (11.2" x 9.05" x 4.33")
OS Support	
Windows 10 IOT Enterprise 64-bit, Linux (Ubuntu 20.04)	
Ordering Information	
FPC-5210-P6	Embedded GPU Computer, Bare BOM, w/6x POEs

1.4. Inside the Package

Upon opening the package, carefully inspect the contents. If any of the items is missing or appears damaged, contact your local dealer or distributor. The package should contain the following items:



1 x FPC-5210 Series
Robust System



1 x User's Manual



1 x CPF-92Q0-C1

1.4.1. Optional Accessories

The following items are normally optional, but some vendors may include them as a standard package, or some vendors may not carry all the items.

WMK-5210

Wall-mount kit for FPC-521x Series



PAC-330W6B











330W AC/DC adapter kit w/ 4-pin terminal block



Introduction

1.4.2. Optional Configuration (CTOS* Kit)

Make the computer more tailored to your needs by selecting one or more components from the list below to be fabricated to the computer.

MXM-KIT-A4500-8GB	MXM 3.1 Type B NVIDIA® Quadro® Embedded A4500-8GB GDDR6 MXM Kit with Heatsink	
MXM-KIT-A4500-16GB	MXM 3.1 Type B NVIDIA® Quadro® Embedded A4500-16GB GDDR6 MXM Kit with Heatsink	
MXM-KIT-A2000-8GB	MXM 3.1 Type A NVIDIA® Quadro Embedded A2000-8GB MXM Kit with Heatsink	
MM-5C-8G/16G/32G	DDR5-4800 8GB/16GB/32G SDRAM DIMM module	
WIFI-IN2550	Intel AX200NGW M.2 Wi-Fi 6 module w/2x30cm internal wires	
ANT-H11	1 x 2dBi HSUPA antenna	
ANT-D11	1 x WiFi dual-band 2.4G/5G antenna	
Core™ i3-12100E	Intel® 12 th Gen. Core™ i3-12100E processor, L3/12M, 3.2G	
Core™ i3-12100TE	Intel® 12 th Gen. Core™ i3-12100TE processor, L3/12M, 2.1G	
Core™ i5-12500E	Intel® 12 th Gen. Core™ i5-12500E processor, L3/18M, 2.9G	
Core™ i5-12500TE	Intel® 12 th Gen. Core™ i5-12500TE processor, L3/18M, 1.9G	
Core™ i7-12700E	Intel® 12 th Gen. Core™ i7-12700E processor, L3/25M, 2.1G	
Core™ i7-12700TE	Intel® 12 th Gen. Core™ i7-12700TE processor, L3/25M, 1.4G	
Core™ i9-12900E	Intel® 12 th Gen. Core™ i9-12900E processor, L3/30M, 2.3G	
Core™ i9-12900TE	Intel® 12 th Gen. Core™ i9-12900 TE processor, L3/30M, 1.1G	

Core™ i9-13900E	Intel® 13 th Gen. Core™ i9-13900E processor, 36M, 1.8G
Core™ i9-13900TE	Intel® 13 th Gen. Core™ i9-13900TE processor, 36M, 1.0G
Core™ i7-13700E	Intel® 13 th Gen. Core™ i7-13700E processor, 30M, 1.9G
Core™ i7-13700TE	Intel® 13 th Gen. Core™ i7-13700TE processor, 30M, 1.1G
Core™ i5-13400E	Intel® 13 th Gen. Core™ i5-13400E processor, 20M, 2.4G
Core™ i5-13500E	Intel® 13 th Gen. Core™ i5-13500E processor, 24M, 2.4G
Core™ i5-13500TE	Intel® 13 th Gen. Core™ i5-13500TE processor, 12M, 1.3G
Core™ i3-13100E	Intel® 13 th Gen. Core™ i3-13100E processor, 12M, 3.3G
Core™ i3-13100TE	Intel® 13 th Gen. Core™ i3-13100TE processor, 12M, 2.4G



*CTOS means Configure-to-Order Service.

This page is intentionally left blank.

Chapter 2

System Overview

System Overview

2.1. Dimensions

FPC-5210-P6

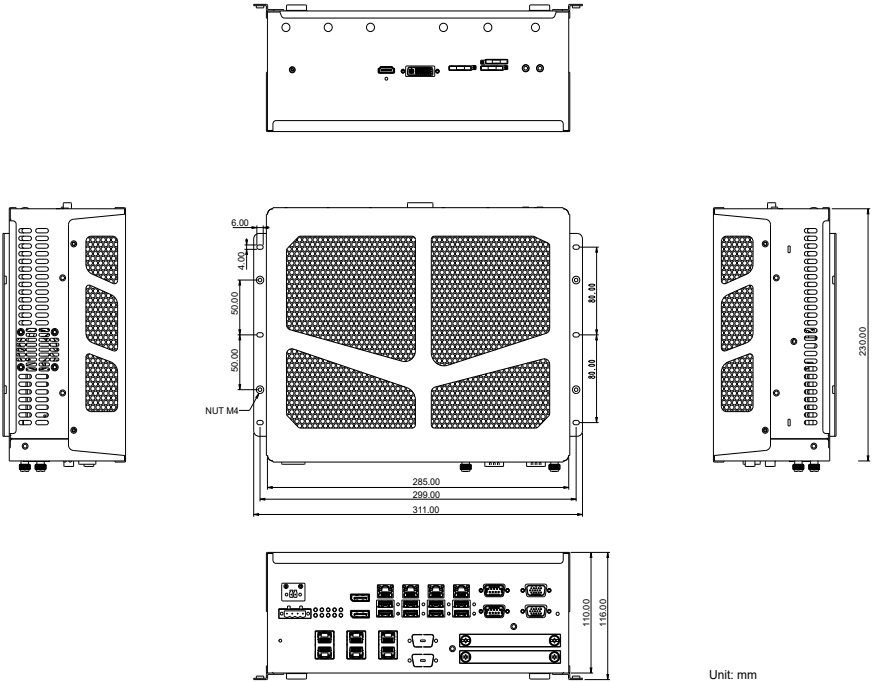

Unit: mm

2.2. Take A Tour

2.2.1. Front View

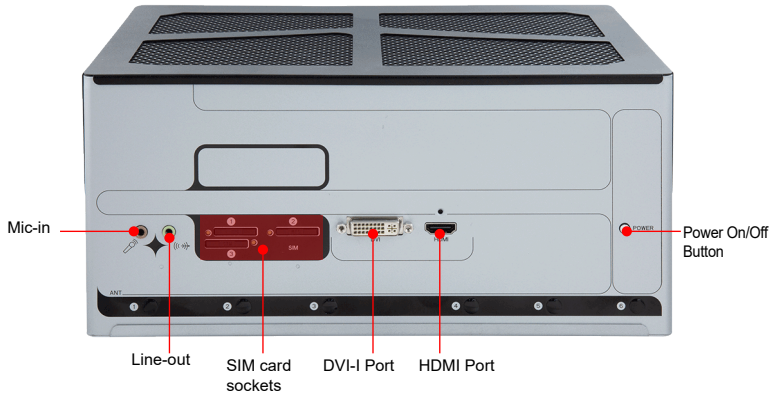

2.2.2. FPC-5210-P6 Rear View

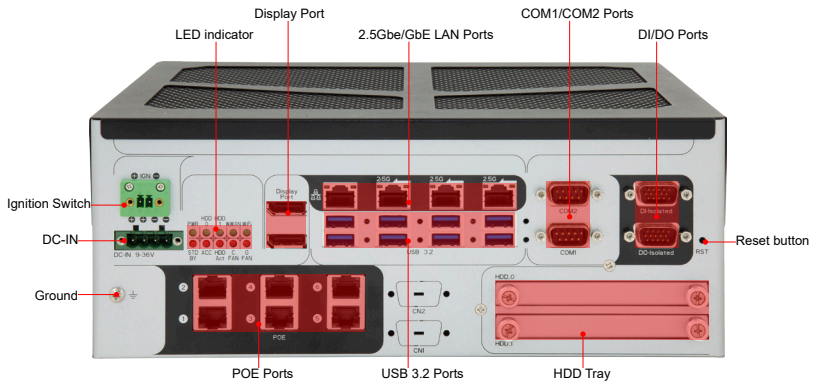

2.3. Driver Installation Notes

The CPU module supports Windows 10 64-bit and Linux. To install the drivers, please go to our website at www.arbor-technology.com and download the driver pack from the product page. Then extract the downloaded file and follow the sequence below to install the drivers:

Chipset → **Graphic** → **Audio** → **Other drivers**

The driver path is listed as below:

Windows 10

Driver	Path
Chipset	\\Chipset\SetupChipset.exe
LAN	\\LAN\Intel\Autorun.exe \\LAN\10G\Windows\Installer\Marvell_FastLinQ_Edge_x64_ver3.1.3.0.msi
VGA	\\Graphics\gfx_win_101.4575.exe
Audio	\\AUDIO\0006-64bit_Win7_Win8_Win81_Win10_R279
ME	\\ME\SetipME.exe
MXM	\\Win10_11x64_(527.27).exe
Serial IO	\\30.100.2131.26_PV_ADL_PCH-S_Win11\SetupSerialIO.exe
VMD	\\VMD\VMD\fvmdflpy-x64

Chapter 3

System Configuration

3.1. Board Layout

Board Top

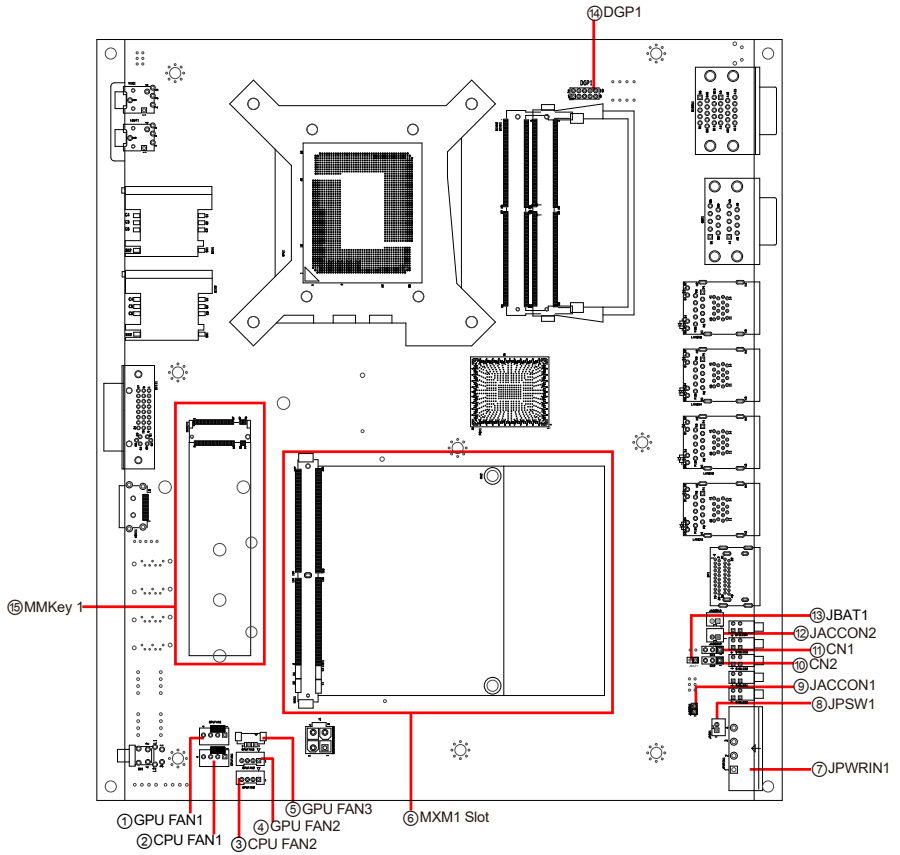

Board Bottom

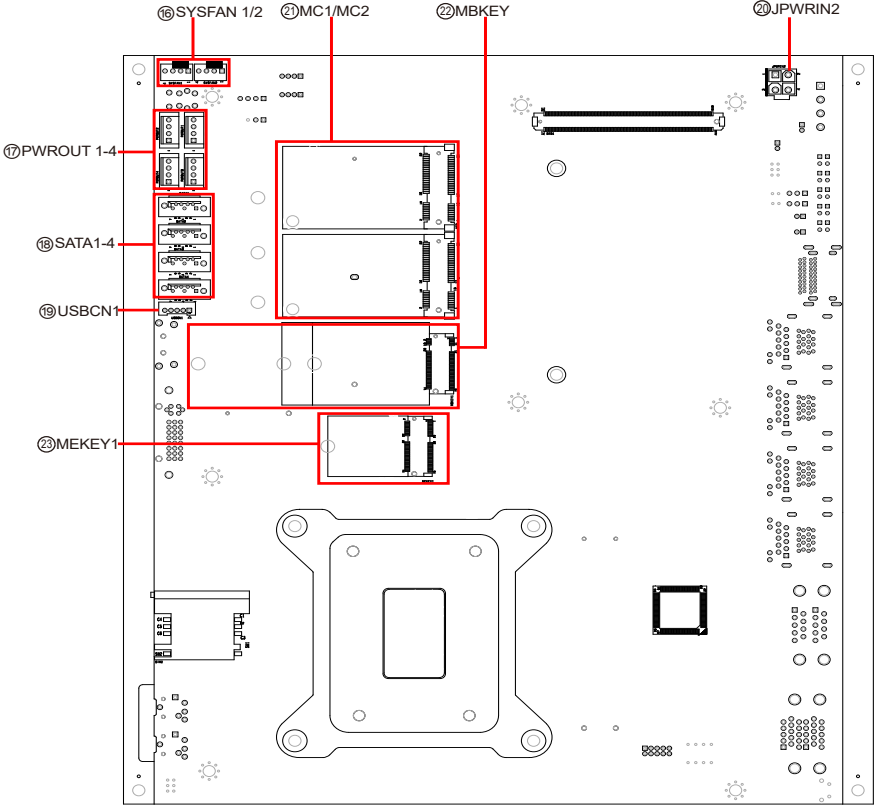

Engine of the Computer

Jumpers & Connectors

Label	Description
① ④ GPU FAN1~2	Fan power connector
⑤ GPU FAN3	Fan power connector
② ③ CPU FAN1	Fan power connector
⑥ MXM1 Slot	MXM Expansion Slot
⑦ JPWRIN1	Power Input
⑧ JPSW1	Power Button
⑩ ⑪ CN1, 2	DP source select
⑨ ⑫ JACCON1, 2	ACC ON Signal
⑬ JBAT1	Clear CMOS settings
⑭ DGP1	Debug Port
⑮ MMKey 1	M.2 M-Key socket
⑯ SYSFAN1/SYSFAN2	System FAN connector
⑰ PWROUT	SATA HDD Power Connector
⑱ SATA	Serial ATA Connector
⑲ USBCN1	USB2.0 wafer connector
⑳ JPWRIN2	Power Input
㉑ MC1/MC2	PCI Express Mini-card Full socket
㉒ MBKEY	M.2 B-Key socket
㉓ MEKEY1	M.2 E-Key socket

3.2. Pinheaders and Connectors

3.2.1 Main board

①④ GPU FAN1~2

Function: Fan Power Connector

Connector Type: Onboard 4-pin header/① pitch 2.54mm/ ④ pitch 2.00mm

Pin Assignment:

Pin Description	
1	GND
2	+12V
3	PWM
4	Control

1	GND
2	+12V
3	PWM
4	Control

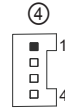
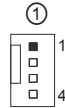

⑤ GPU FAN3

Function: Fan Power Connector

Connector Type: Onboard 4-pin header / pitch 1.25mm

Pin Assignment:

Pin Description	
4	Control
3	PWM
2	+12V
1	GND

4	Control
3	PWM
2	+12V
1	GND



Please note that all GPU FAN connector1-3 are only initiated single device at a time simultaneously.

②③ CPU FAN1/CPU FAN2

Function: CPUFAN1/CPUFAN2

Connector Type: Onboard 4-pin header/ ②pitch 2.54mm/ ③2.00mm

Pin Assignment:

Pin Description	
1	GND
2	+12V
3	PWM
4	Control

1	GND
2	+12V
3	PWM
4	Control

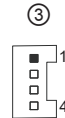
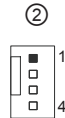

Please note that all CPU FAN connectors are only initiated single device at a time simultaneously..

⑥ **MXM Expansion slot**

Function: External MXM slot
Connector Type: MXM3.1 TYPE A/B GPU Slot
Pin Assignment: The pin assignments conform to the industry standard

⑦ **JPWRIN1**

Function Power Input
Connector Type: Onboard 4-Pin Terminal block
Pin Assignment:

Pin	Description
1	DCIN
2	DCIN
3	GND
4	GND

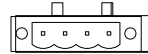

⑧ **JPSW1**

Function: Power Button
Connector Type: 2-pin wafer
Pin Assignment:

Pin	Desc.
1	PWR_IN_SW#
2	GND



⑩ ⑪ **CN1/CN2**

Function DP source select
Connector Type: Onboard 3-pin header
Pin Assignment:

Pin	Description
1-2	GPU
2-3	CPU(default)



⑨ JACCON1

Function Vehicle Acc Mode Selection

Connector Type: Onboard 2-pin header

Pin Assignment: **Description**

Enable: 1-2 short (default)



Disable: 1-2 open



⑫ JACCON2

Function ACC ON Signal

Connector Type: Onboard 2-pin header

Pin Assignment: **Pin Description**

1 ACC_ON

2 GND

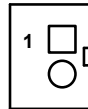

⑬ JBAT1

Function: Clear CMOS settings

Connector Type: Onboard 2x1-pin box connector

Pin Assignment: **Pin Desc.**

1 RTCRST#

2 GND



⑭ **DGP1**

Function: Debug Port
Connector Type: Onboard 10-pin header
Pin Assignment:

Pin	Desc.	Pin	Desc.
1	ESPI_CLK	2	GND
3	ESPI_CS0#	4	ESPI_IO0
5	ESPI_RST#	6	V3.3A
7	ESPI_IO3	8	ESPI_IO2
9	V3.3S	10	ESPI_IO1

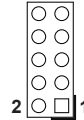

⑮ **MMKEY1**

Function: M.2 M-Key Connector
Connector Type: M.2 75-pin M-Key connector for PCIe x4/SATA-III SSD storage, supporting 22x42 / 22x80 modules
Pin Assignment: The pin assignments conform to the industry standard.



⑯ **SYSFAN 1/2**

Function: Fan Power Connector
Connector Type: Onboard 2.54mm pitch 1x4-pin one-wall wafer connector.
Pin Assignment:

Pin	Description
1	GND
2	+12V
3	NC
4	NC



⑰ PWROUT1~4

Function: SATA HDD Power Connector
Connector Type: 2.54mm pitch 1x4-pin one-wall connector
Pin Assignment:

Pin	Description
1	+5V
2	GND
3	GND
4	+12V



⑱ SATA1~4

Function: Serial ATA Connector
Connector Type: On-board Standard 7-pin Serial ATA Connector
Pin Assignment:

Pin	Description
1	GND
2	TX+
3	TX-
4	GND
5	RX-
6	RX+
7	GND

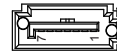

⑲ USBCN1

Function: USB2.0 Wafer
Connector Type: On-board onboard Type 5pin wafer connector
Pin Assignment:

Pin	Description.
1	+5V
2	D-
3	D+
4	GND
5	GND



⑳ JPWRIN2

Function: VGA card power
Connector Type: onboard 2.54mm pitch 4-pin wafer
Pin Assignment:

Pin	Desc.
1	GND
2	GND
3	DCIN
4	DCIN

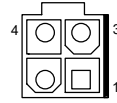

㉑ MC1/MC2

Function: PCI Express Mini-card Full socked
Connector Type: Onboard 0.8mm pitch 52-pin edge card connector.
Pin Assignment:

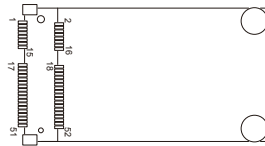

㉒ MBKEY1

Function: M.2 B-Key socket
Connector Type: M.2 B-Key
Pin Assignment: The pin assignments conform to the industry standard.

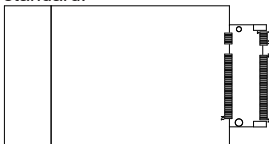

②③ MEKEY1

Function: M.2 E-Key socket (w/ CNVi+USB2.0) for optional Wi-Fi/BT

Connector Type: M.2 E-Key 2230 Socket

Pin Assignment: The pin assignments conform to the industry standard.

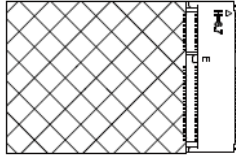

Engine of the Computer

FPC-5210-P6 Front side

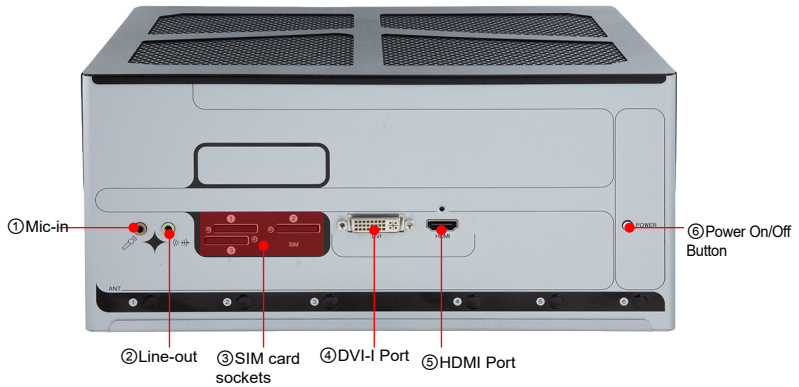

FPC-5210-P6 Rear side

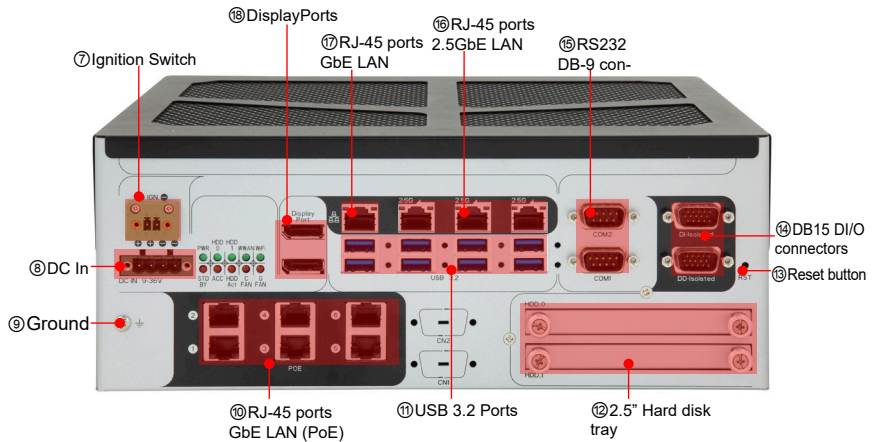

③ SIM Card socket

Function: SIM Card Socket
Connector Type: 6-pin SIM card socket
Pin Assignment:

Pin	Desc.	Pin	Desc.
C1	VCC	C2	RST
C3	CLK	C5	GND
C6	VPP	C7	I/O

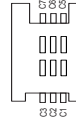

⑦ Ignition Switch

Function: For vehicle application
Connector Type: 2-Pin Terminal block
Pin Assignment:

Pin	Desc.
1	V+
2	V-

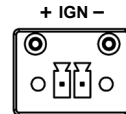

⑧ PWRIN3

Function: DC Adapter Power Input for expansion card
Connector Type: 4-Pin Terminal block
Pin Assignment:

Pin	Desc.
1	V+
2	V+
3	V-
4	V-



⑬ ⑭ DIOCN1

Function: Isolated DIO

Connector Type: 15-pin D-sub male connector

Pin Assignment:

DIOCN1 (DOWN)		DIOCN1 (UP)	
NO.	Desc.	NO.	Desc
A1	DOUT_00	B1	DI_00
A2	DOUT_01	B2	DI_01
A3	DOUT_02	B3	DI_02
A4	DOUT_03	B4	DI_03
A5	DOUT_04	B5	DI_04
A6	DOUT_05	B6	DI_05
A7	DOUT_06	B7	DI_06
A8	DOUT_07	B8	DI_07
A9	NC	B9	NC
A10	NC	B10	NC
A11	NC	B11	NC
A12	NC	B12	NC
A13	NC	B13	24V_ISO
A14	GND_ISO	B14	COM1
A15	GND_ISO	B15	GND_24V_ISO

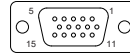

⑮ **COM1, COM2**

Function: RS-232/422/485 Selectable Serial Port

Connector Type: 9-pin D-sub male connector

Pin Assignment:

	Pin	Desc.	Pin	Desc
RS-232	1	DCD	6	DSR
	2	RXD	7	RTS
	3	TXD	8	CTS
	4	DTR	9	RI
	5	GND	10	N.C
RS-422	1	COM_422 TX-		
	2	COM_422 TX+		
	3	COM_422 RX+		
	4	COM_422 RX-		
	5	GND		
RS-485	1	COM_485 D-		
	2	COM_485 D+		
	5	GND		

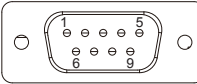

Engine of the Computer

LED Indicator Statement

Function: RS-232/422/485 Selectable Serial Port

Pin Assignment:

Function	LED Color	Desc.
STANDBY	Red	This LED lights Red when in standby mode
Power Status (PWR)	Green	This LED lights Red when power is on
ACC	Red	This LED lights Red when ACC power is on
HDD_0	Green	This LED lights when the HDD/SSD was detected in HDD1
HDD_ACT	Red	This LED lights when HDD_0/ HDD_1 SATA is accessed
HDD_1	Green	This LED lights when the system detect SATA device
CPU FAN	Red	This LED lights when CPU SMART FAN was activated
	Flashing	This LED light when CPU SMART FAN is abnormal
WWAN	Green	This LED lights when the system detect WWAN device
GPU FAN	Red	This LED lights wh GPU SMART FAN was activated
	Flashing	This LED light when GPU SMART FAN is abnormal
WIFI	Green	This LED lights when the system detect WIFI device

Please note that the LED indicators of "WWAN" and "WIFI" LED status may be various by different wifi devices.



Chapter 4

Installation and Maintenance

Installation & Maintenance

4.1. Install Hardware

The FPC-5210 Series is constructed based on modular design to make it easy for users to add hardware or to maintain the computer. The following sections will guide you to the simple hardware installations for the computer.

4.1.1. Open the Computer

For the computer, removing the top and bottom covers is essential to open the computer and access the inside. Follow through the steps below to remove the top cover and bottom cover from the computer.

4.1.1.2. Remove Top Cover

All jumpers, CPU socket, MiniCard socket, SDRAM SO-DIMM slots, DIO/LPT ports are built on the top side of the main board. To access these components, the computer's top cover has to be removed. Follow through the steps below to remove the top cover.

FPC-5210-P6

This section will use FPC-5210-P6 as the installation example.

1. Loosen and remove the 4 screws of the top case from both side as shown below.

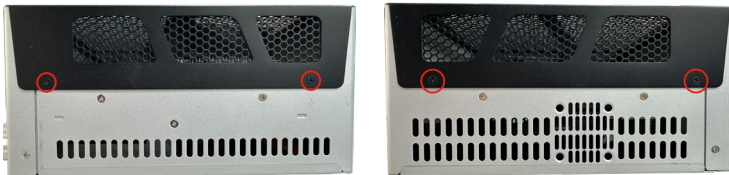

2. Carefully lift the top cover and then completely part the top and slide the side cover from the computer.



The inside of the computer comes to view.



4.1.1.3. Remove Bottom Cover

1. Loosen and remove the 2 screws at the bottom as shown below.

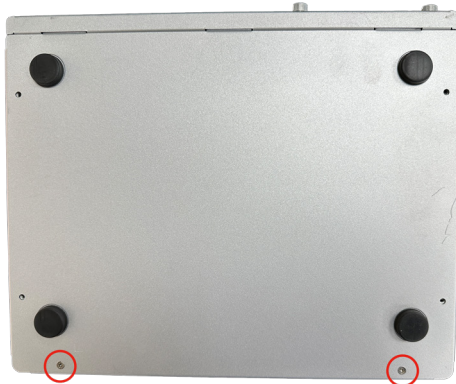

3. Carefully lift the bottom over and then completely part the side cover from the computer.



The inside of the computer comes to view.

4.1.2. Install CPU

1. Remove the top and side cover from the computer as described in [4.1.1.3. Remove Bottom Cover on page 32.](#)
2. Locate the CPU socket on the main board

The processor socket comes with a lever to secure the processor. Please refer to the pictures step by step as below and note that the cover of the socket must always be installed during transportation to avoid damage to the socket.

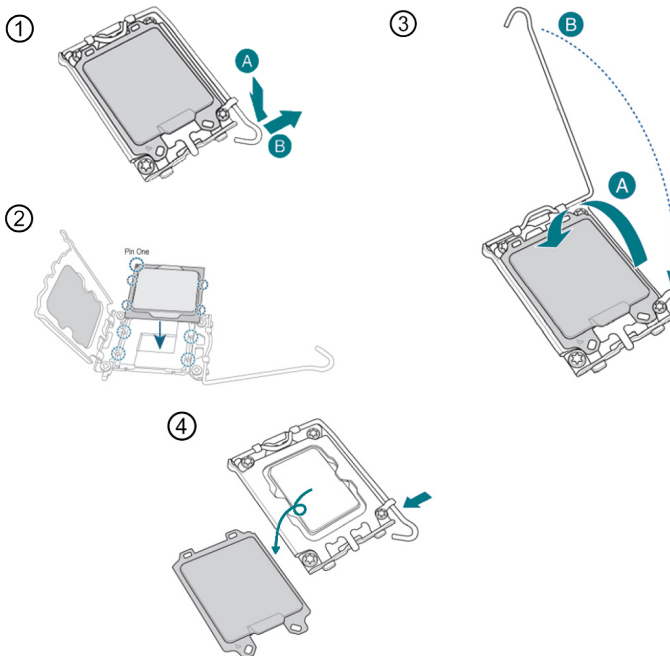

Then fix the CPU fan in place by fastening the four screws of the fan. Connect the fan connector port to the board as below.

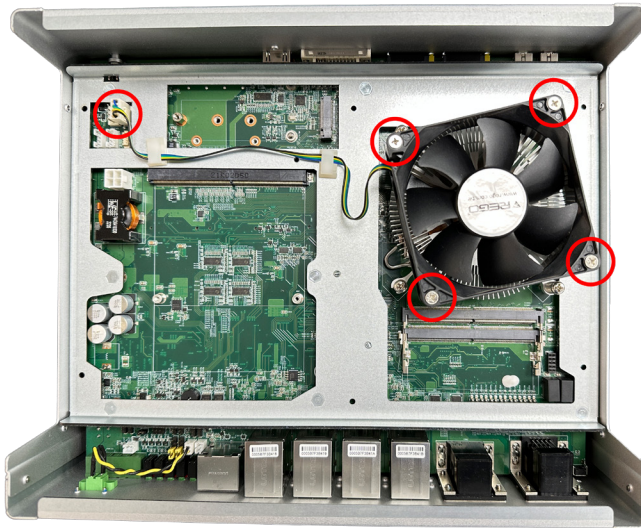

3. Restore the top and back cover to the computer by fastening the all screws.

4.1.3. Install/Uninstall Memory Modules

The main board has two memory module (DIMM) sockets. Increase memory capacity to make programs run faster on the system. The memory module for the FPC-5210 Series' SO-DIMM sockets should be a 262-pin DDR5 with a "key notch" off the centre among the pins, which enables the memory module for particular applications. There are another two notches at each left and right side of the memory module to help fix the module in the socket.

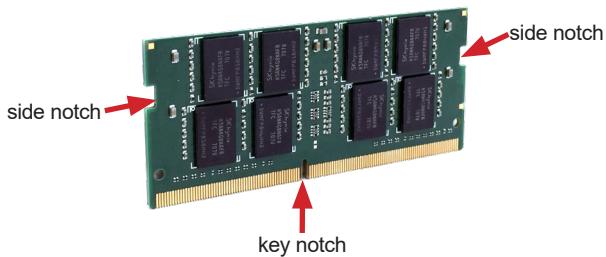

The computer has two 262-pin DDR5 SO-DIMM sockets that each socket support up to 64 GB maximum system memory. To install a memory module:

To install a DDR5 memory module:

1. Remove the top cover from the computer as described in [4.1.1.2. Remove Top Cover](#) on page 30
2. Locate the SO-DIMM sockets on the main board.

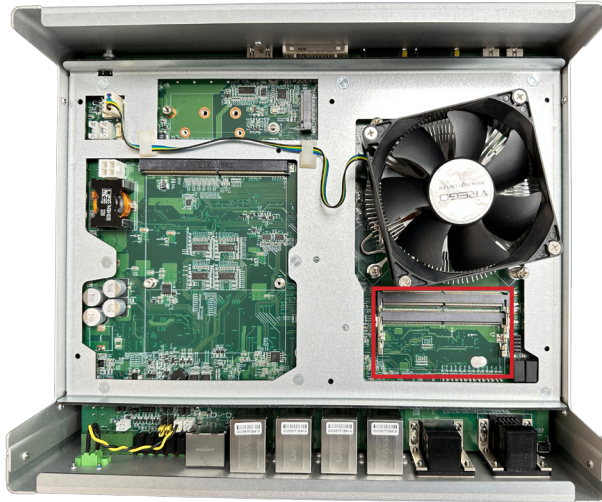

3. Align the notch on the memory module with the key in the module socket.

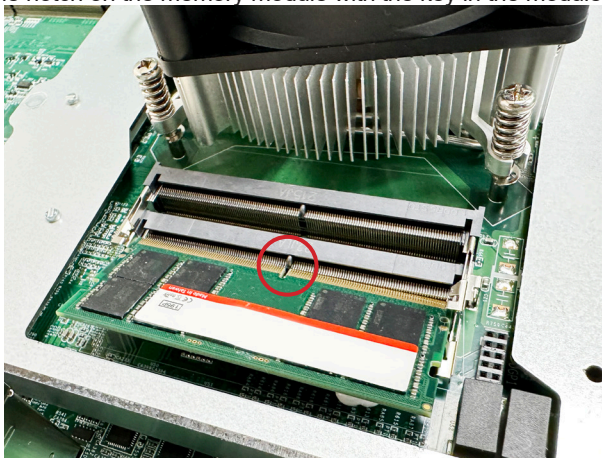

Installation & Maintenance

4. Slide the module into place. Once the memory module is fully inserted into the socket, press down on the top edge of the device to latch it into place.

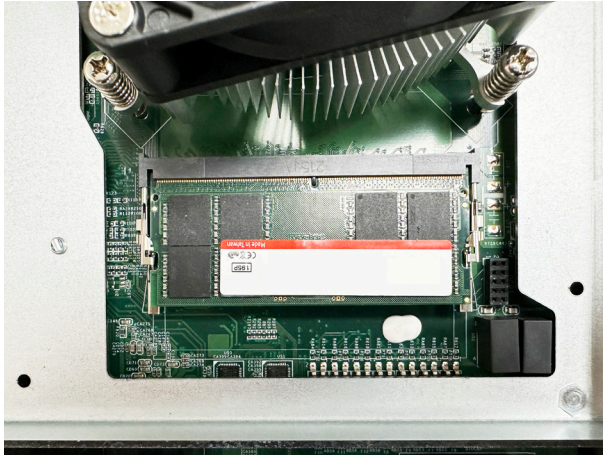

5. This way it's flat to the laptop's bottom. The carrier should snap into place with latches.
6. Restore the top cover to the computer.

To uninstall a DDR5 memory module:

1. Pull back both latches from the SO-DIMM socket.

The DDR5 memory module will be auto-released from the socket.

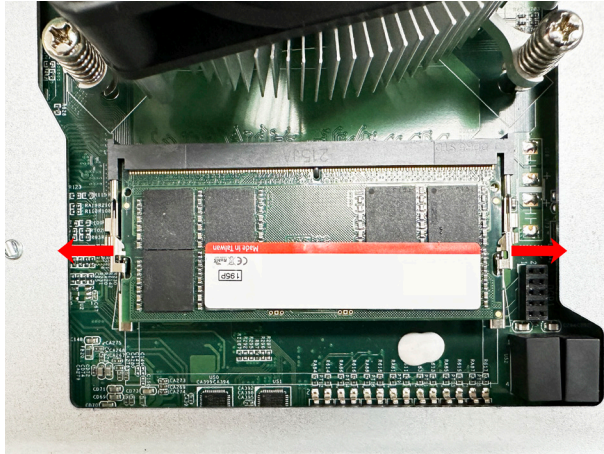

2. Remove the memory module.
3. Restore the top cover to the computer.

4.1.4. Installing M.2 Storage Module

The computer has a M.2 M-Key socket for NVME SSD storage. This section will use a 22 x 80 form factor as the installation example.

1. Remove the top cover from the computer as described in [4.1.1.2. Remove Top Cover](#) on page [30](#) Locate the M.2 on-board connector.

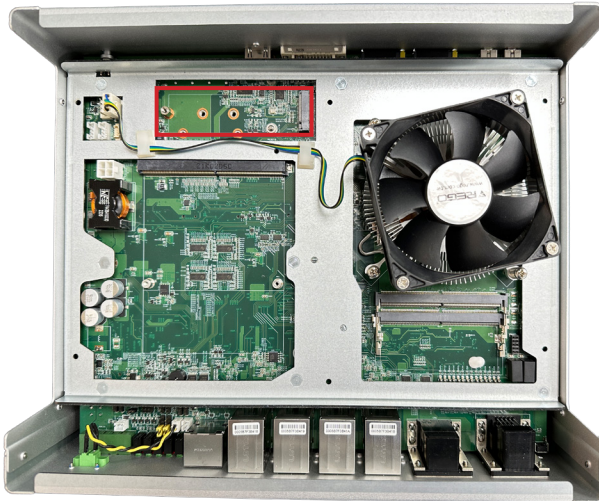

2. Insert the M.2 module into the socket by aligning the notch on the module with the small slot on the M.2 socket.

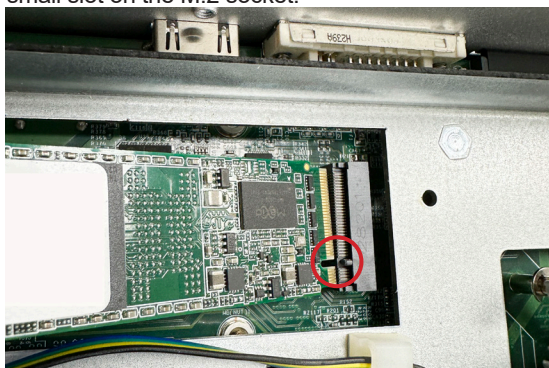

3. Insert and fasten the screw into the standoff.

4.1.5. Install Wi-Fi Module

1. Remove the back cover from the computer as described in [Section 4.1.1.3. Remove Bottom Cover on page 32.](#)
2. Locate the **M.2 E-Key** socket for wireless module.

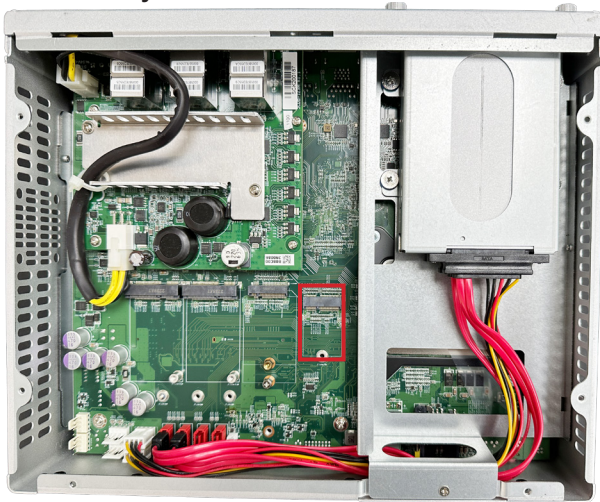

3. Prepare the Wi-Fi module kit. The module is a **M.2 E-Key** socket form factor, with two MHF connectors, one is "MAIN", and the other is "AUX".

Installation & Maintenance

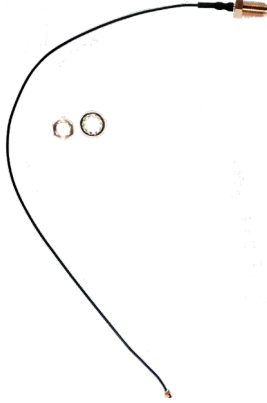

Two MHF connectors, one is “MAIN” (marked 2), the other is “AUX” (marked 1).



4. Have the RF antenna. The antenna has an SMA connector on one end and an MHF connector on the other.

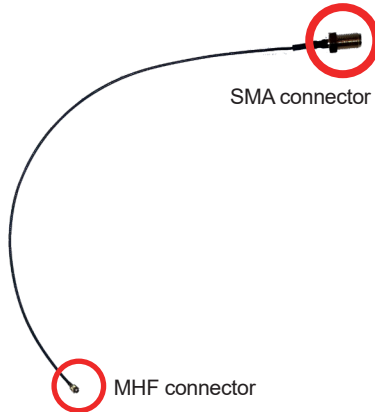

5. Connect the RF antenna’s MHF connector to the Wi-Fi module’s main connector marked 0. If you are going to connect a secondary antenna, connect it to the connector marked 1.

Connect the RF antenna's MHF connector to the Wi-Fi module's main connector (marked 2)

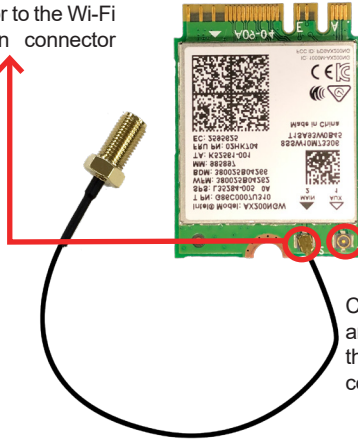

Connect the secondary RF antenna's MHF connector to the Wi-Fi module's secondary connector (marked 1)

6. Plug the Wi-Fi module to the socket's connector by a slanted angle. Fully plug the module, and note the notch on the wireless module should meet the break of the connector.



The module's key notch should meet the connector's break.

7. Press the module down and fix the module in place using one screw.



8. Locate the SMA antenna holes on front panel. Remove the plastic plug to

Installation & Maintenance

make an antenna hole. Keep the plastic plug for any possible restoration in the future.

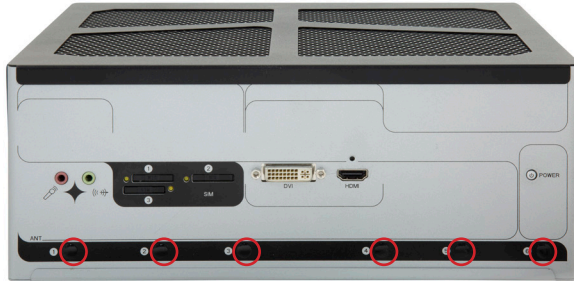

9. From the other end of the RF antenna, which is an SMA connector, remove the washer and the nut. Note the SMA connector has the form of a threaded bolt, with one flat side.

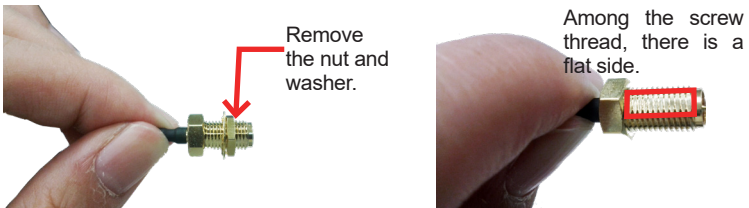

10. Pull the SMA connector through the above mentioned antenna hole. Note to meet the aforesaid flattened side with the antenna hole's flat side.

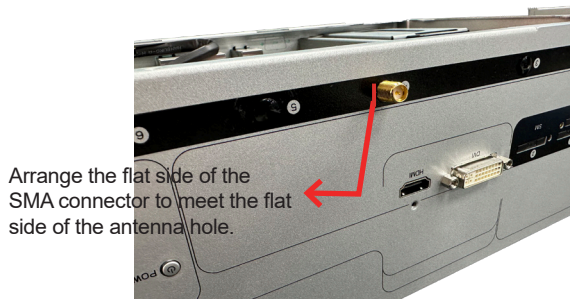

11. Mount the washer first and then the nut to the SMA connector. Make sure the nut is tightened.
12. Have the external antenna(s). Screw and tightly fasten the antenna(s) to the SMA connector.



13. After completing the required hardware installation, assemble the computer by performing the preceding steps in reverse order.

4.1.5. Install Internal SATA Storage Device

The computer supports two 2.5" SATA storage devices to work inside the computer for RAID. The following will guide you to install two SATA HDD/SSD.

1. Find the HDD/SSD brackets. Loosen the screws as marked in the illustration below and take the bracket out of the computer. Then dismount the bracket from the computer.



2. For the 1st storage bracket, slide the HDD/SSD storage device into the bracket.

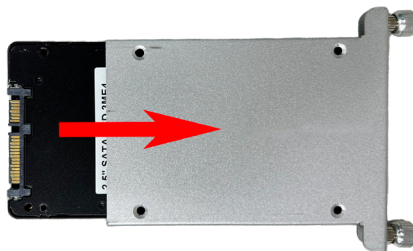

3. Fix the storage device in place by fastening the four screws of the bracket.

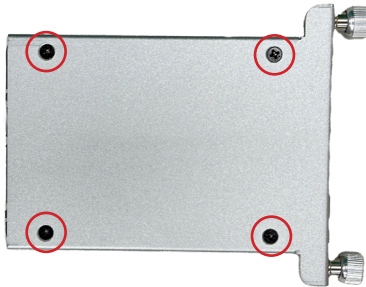

4. If you are going to install the 2nd HDD/SSD storage device, slide the storage device into the bracket and fix it in place in the same way.
5. Restore the HDD/SSD bracket to the computer.

4.1.6. Install MXM3.1 TYPE A/B GPU Cards

To install a PCI or PCI Express card:

1. Remove the top cover from the computer as described in section [4.1.1.2. Remove Top Cover](#) on page [30](#)
2. Locate the MXM3.1 TYPE A/B GPU socket for GPU card.

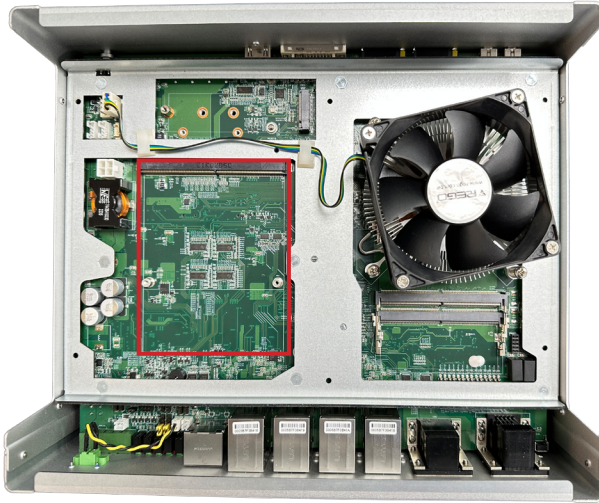

3. Install the graphic card into the computer correctly.
 - a. Align the graphics card notch with the slot on the board and push the graphics card into the slot until firmly inserted.
 - b. Then tighten the screws to secure GPU card.



4. Connect the fan connector port to the board as below.

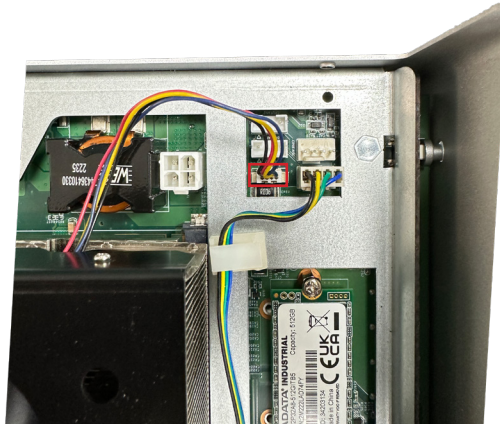

5. Restore the top cover to the computer.

4.2. Wire DC-in Power Source

4.2.1 Automation Mode

Follow the instructions below for connecting the computer to a DC-input power source.



Warning Only trained and qualified personnel are allowed to install or replace this equipment.

1. Before wiring, make sure the power source is disconnected.
2. Find the terminal block in the accessory box.
3. Use the wire-stripping tool to strip a short insulation segment from the output wires of the DC power source.
4. Identify the positive and negative feed positions for the terminal block connection. See the symbols printed on the rear panel indicating the polarities and DC-input power range in voltage.
5. Insert the exposed wires into the terminal block plugs. Only wires with insulation should extend from the terminal block plugs. Note that the polarities between the wires and the terminal block plugs must be positive and negative to negative.
6. Use a slotted screwdriver to tighten the captive screws. Plug the terminal block firmly, which wired, into the receptacle on the rear panel.

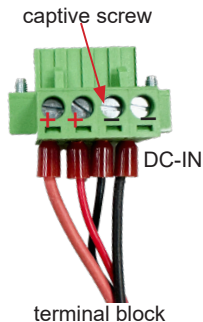

4.2.2 Vehicle Application Mode

Follow the instructions below for connecting the computer to a vehicle power source.

1. Make sure JACCON1 jumper is open for vehicle power mode. (Refer to [3.2. Pinheaders and Connectors](#) on page 17.
2. For vehicle application, DC power Input wiring pin configuration is as below. Please connect the Acc pin with your car Acc, and the device will be activated when you turn your ignition key to Acc.

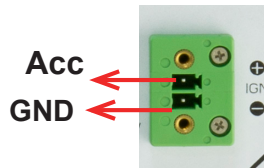

This page is intentionally left blank.

Chapter 5

BIOS

BIOS

The BIOS Setup utility for the FPC-5210 Series is featured by American Megatrends Inc to configure the system settings stored in the system's BIOS ROM. The BIOS is activated once the computer powers on. When the computer is off, the battery on the main board supplies power to BIOS RAM.

To enter the BIOS Setup utility, keep hitting the “Delete” key upon powering on the computer.

The featured settings are:

Menu	Description
Main	See 5.1. Main on page 54
Advanced	See 5.2. Advanced on page 55
Chipset	See 5.3. Chipset on page 73
Security	See 5.4. Security on page 102
Boot	See 5.5. Boot on page 78
Save & Exit	See 5.6. Save & Exit on page 80
MEBx	See 5.7. MEBx on page 81

The screenshot displays the Aptio Setup - AMI BIOS interface. At the top, a navigation bar includes: Main, Advanced, Chipset, Security, Boot, Save & Exit, and MEBx. The main content area is divided into two columns. The left column lists system information, and the right column provides navigation instructions.

Aptio Setup - AMI	
Main Advanced Chipset Security Boot Save & Exit MEBx	
BIOS Information Project Version: FPC-5210 1.01 Build Date and Time: 04/26/2023 10:51:26 Access Level: Administrator Processor Information Name: AlderLake DT Stepping: H0 Microcode Revision: 1E IGFX GOP Version Total Memory: 32768 MB Memory Frequency: 4800 MHz PCH Information Stepping: B1 ME FW Version: 16.0.15.1735 ME Firmware SKU: Corporate SKU System Date : [Sat 06/17/2023] System Time : [16:59:44]	Set the Date. Use Tab to switch between Date elements. Default Ranges: Year: 1998-9999 Months: 1-12 Days: Dependent on month Range of Years may vary. ++: Select Screen ↑↓: Select Item Enter: Select +/-: Change Opt. F1: General Help F2: Previous Values F9: Optimized Defaults F10: Save & Exit ESC: Exit
Version 2.22.1286 Copyright (C) 2023 AMI	

Key Commands

The BIOS Setup utility relies on a keyboard to receive user's instructions. Hit the following keys to navigate within the utility and use the utility.

Keystroke	Function
← →	Moves left/right between the top menus.
↓ ↑	Moves up/down between highlight items.
Enter	Selects an highlighted item/field.
Esc	<ul style="list-style-type: none"> ▶ On the top menus: Use Esc to quit the utility without saving changes to CMOS. (The screen will prompt a message asking you to select OK or Cancel to exit discarding changes. ▶ On the submenus: Use Esc to quit current screen and return to the top menu.
Page Up / +	Increases current value to the next higher value or switches between available options.
Page Down / -	Decreases current value to the next lower value or switches between available options.
F1	Opens the Help of the BIOS Setup utility.
F2	Previous values
F9	Optimized defaults
F10	Exits the utility saving the changes that have been made. (The screen then prompts a message asking you to select OK or Cancel to exit saving changes.)

Note: Pay attention to the "WARNING" that shows at the left pane onscreen when making any change to the BIOS settings.

This BIOS Setup utility is updated from time to time to improve system performance and hence the screenshots hereinafter may not fully comply with what you actually have onscreen.

BIOS

5.1. Main

The **Main** menu features the settings of **System Date** and **System Time** and displays some BIOS info.

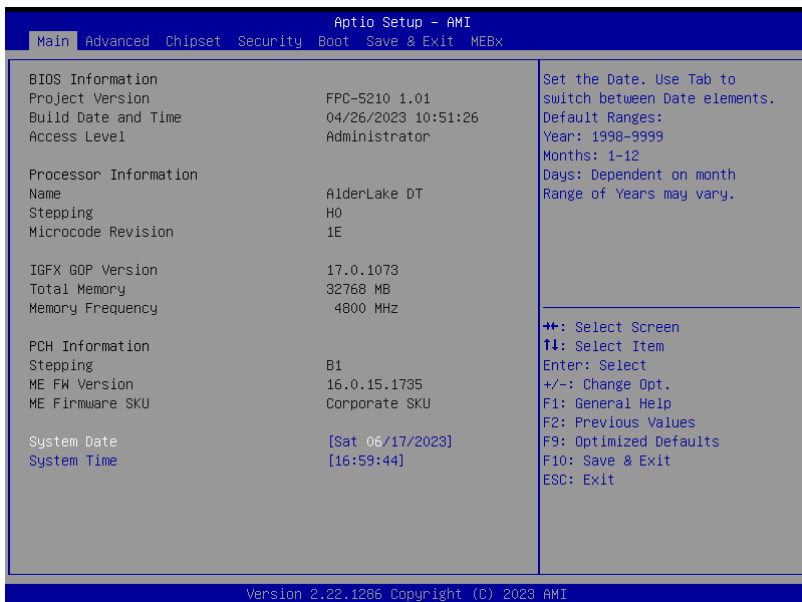

The featured settings are:

Setting	Description
System Date	Set the system date. Use Tab to switch between Data elements. Note that the 'Day' automatically changes when you set the date. ▶ The date format is: Day: Sun to Sat Month: 1 to 12 Date: 1 to 31 Year: 1998 to 2099
System Time	Set the system time. Use Tab to switch between Time elements. ▶ The time format is: Hour: 00 to 23 Minute: 00 to 59 Second: 00 to 59

5.2. Advanced

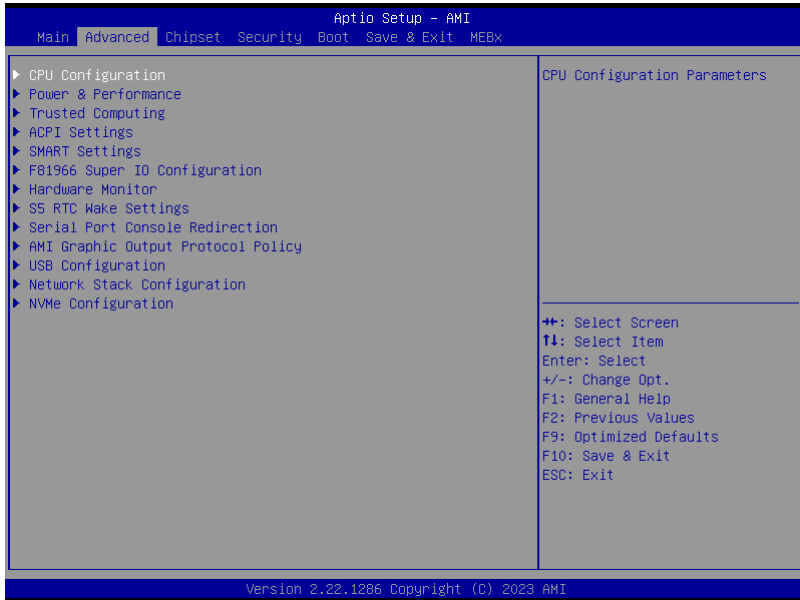

The featured settings and submenus are:

Setting	Description
CPU Configuration	See 5.2.1. CPU Configuration on page 57
Power & Performance	See 5.2.2. Power & Performance on page 58
Trusted Computing	See 5.2.3. Trusted Computing on page 60
ACPI Settings	See 5.2.4. ACPI Settings on page 61
SMART Settings	See 5.2.5. Smart Settings on page 62
FP81966 Super IO Configuration	See 5.2.6. F81966 Super IO Configuration on page 63
Hardware Monitor	See 5.2.7. Hardware Monitor on page 64
SS RTC Wake Settings	See 5.2.8. S5 RTC Wake Settings on page 65
Serial Port Console Redirection	See 5.2.9. Serial Port Console Redirection on page 66
AMI Graphic Outut protocol policy	See 5.2.10. AMI Graphic Output Protocol Policy on page 68

BIOS

USB Configuration	See 5.2.12. USB Configuration on page 69
Network Stack Configuration	See 5.2.13. Network Stack Configuration on page 71
NVMe Configuration	See 5.2.14. NVME Configuration on page 72

5.2.1. CPU Configuration

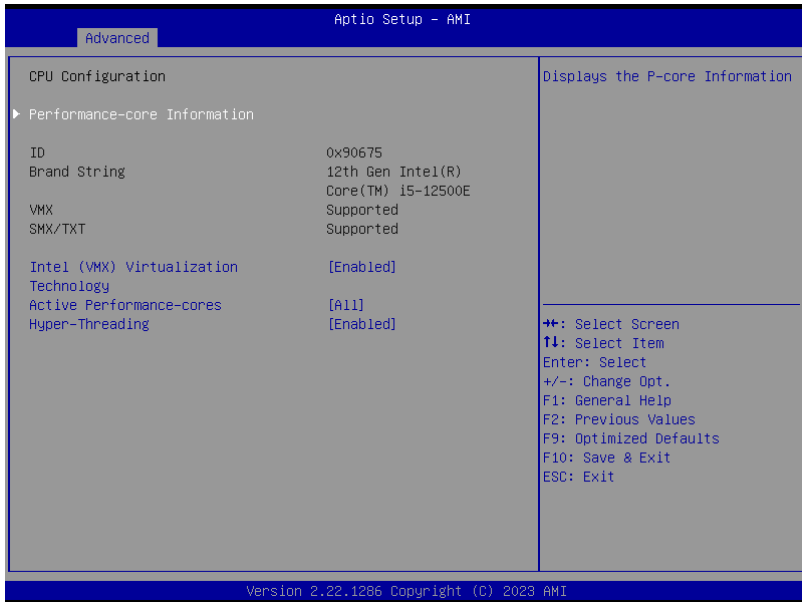

The features settings are:

Setting	Description
Performance-core Information	Display the P-core information
Intel (VMX) Virtualization Technology	When enabled, a VMM can utilize the additional hardware capabilities provided by Vanderpool Technology. ▶ Options: Enabled (default) or Disabled
Active Performance Cores	Number of cores to enable in each processor package. ▶ Options: All (default) and 1, 2, 3, 4, 5
Hyper-Threading	Enabled (default) for Windows XP and Linux (OS optimized for Hyper-Threading Technology) and Disabled for other OS (OS not optimized or Hyper-Threading Technology). When disabled only one thread per enabled core is enabled.

5.2.2. Power & Performance

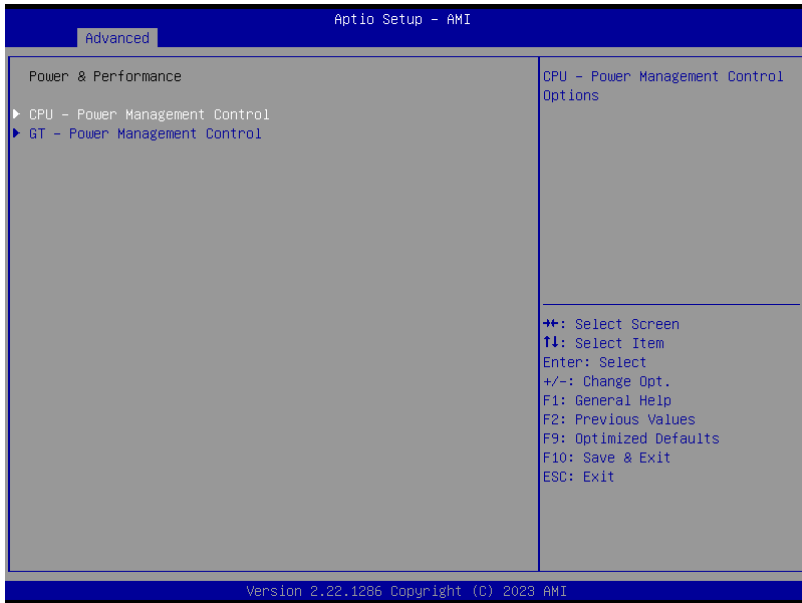

The features settings are:

Setting	Description
CPU - Power management Control	<p>CPU - Power Management Control Options Control CPU Power Management:</p> <ul style="list-style-type: none"> ▶ Options: Boot performance mode: Max Battery, Max Non-Turbo performance, Turbo performance(Default) <p>Control CPU Power Management:</p> <p>Intel(R) SpeedStep(tm):</p> <ul style="list-style-type: none"> ▶ Options: Disable(Default), Enabled <p>Turbo Mode: Enable/Disable peocessor Turbo Mode.</p> <ul style="list-style-type: none"> ▶ Options: Turbo Mode: Disable(Default), Enabled <p>CPU - Power Management Control Options</p>

GT - Power Management Control	<p>RC6(Render Standby): Check to enable render standby ▶ Options: Disabled / Enabled(Default)</p> <p>Maximum GT frequency: Maxium GT frequency limited by the user. Choose between 300MHz and 1450MHz. ▶ Options: Default Max Frequency(Default), 100Mhz~1200Mhz</p> <p>Disable Turbo GT Frequency: Enabled/Disabled GT Frequency. Options: Disabled(Default) / Enabled</p>
--------------------------------------	---

5.2.3. Trusted Computing

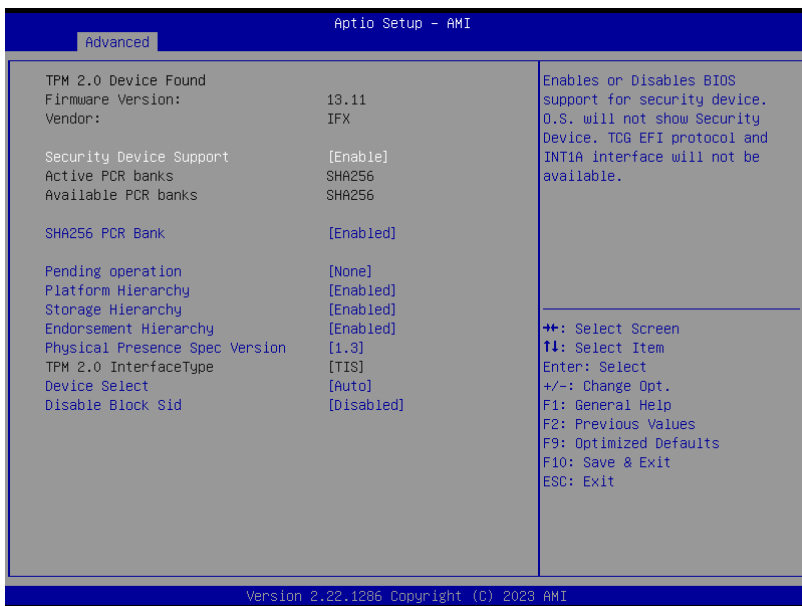

The features settings are:

Setting	Description
Security Device Support	Enable (default) or Disable BIOS support for security device.
Pending operation	Schedule an Operation for the security Device. Your computer will reboot during restart in order to change State of Security Device. ▶ Options: None (default) and TPM Clear
SHA256 PCR Bank	Enable (default) or Disable SHA256 PCR Bank
Pending Operation	Use this item to schedule an operation for the security device. NOTE: Your computer will reboot during restart in order to change state of security device
Platform Hierarchy	Enable (default) or Disable Platform Hierarchy
Storage Hierarchy	Enable (default) or Disable Storage Hierarchy
Endorsement Hierarchy	Enable (default) or Disable Endorsement Hierarchy
Physical Peresence Spec Version	Select to tell O.S. to support PPI Spec Version. Options: 1.2 or 1.3
Device Select	Select TPM devices Options: TPM1.2 , TPM2.0 and Auto
Disable Block Sid	Override to allow SID authentication in TCG Storage device. Options: Enabled or Disabled

5.2.4. ACPI Settings

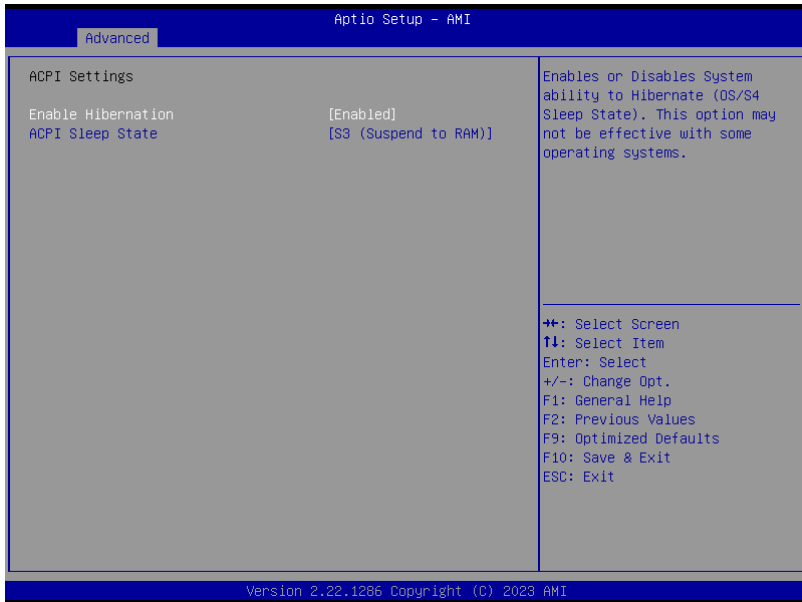

The features settings are:

Setting	Description
Enable Hibernation	Enables (default) or Disables System ability to Hibernate (OS/S4 Sleep State). This option may be not effective with some OS.
ACPI Sleep State	Select ACPI sleep state the system will enter when the SUSPEND button is pressed. ► Options: Suspend Disabled and S3 (Suspend to RAM) (default)

BIOS

5.2.5. Smart Settings

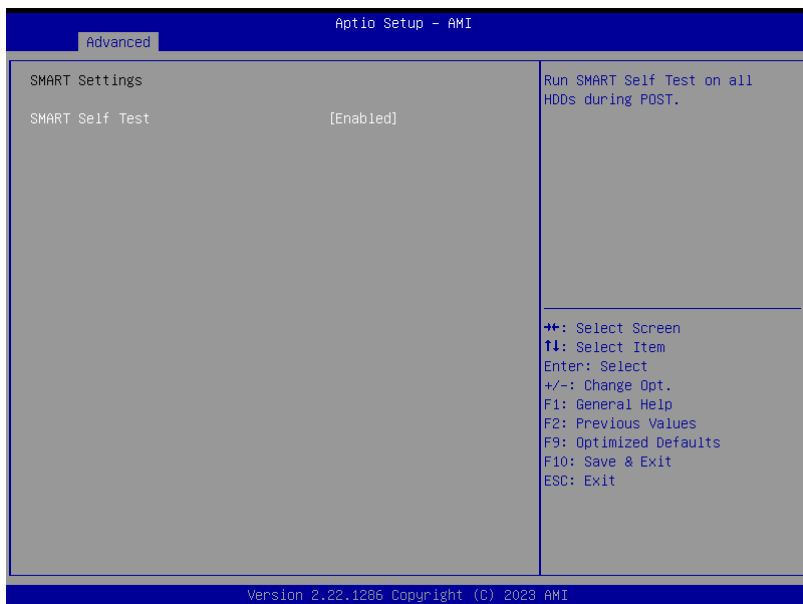

Setting	Description
Smart Settings	Run Smart Self Test on all HDDs during POST. Options: Enabled (default) or Disabled

5.2.6. F81966 Super IO Configuration



Super IO Chip F81866 Settings

Setting	Description
Serial Port Configuration	
Serial Port 1-2 Configuration	Enable (default) or Disable Serial Port (COM). Select RS-232 (default), RS-422 , RS-485 , or RS-485 Termination Resistor

5.2.7. Hardware Monitor

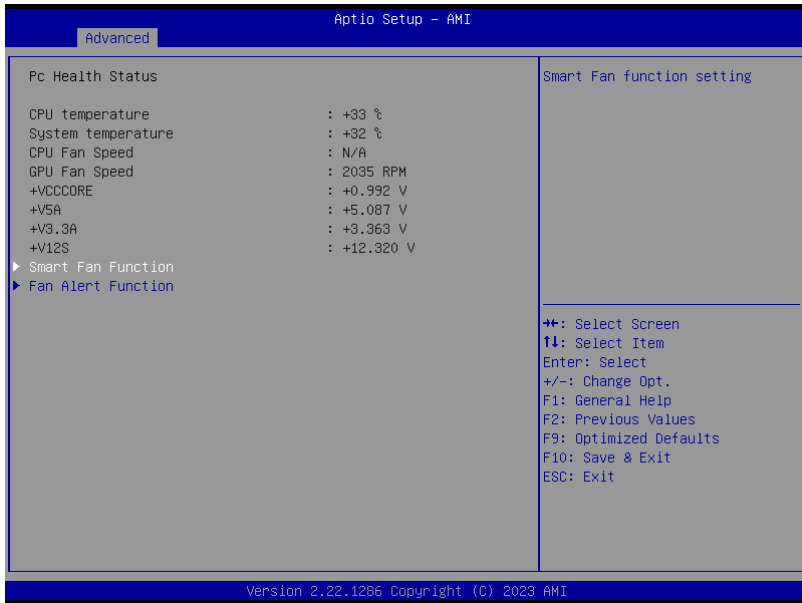

The features settings are:

Setting	Description
SmartFan Function	CPU Smart Fan function settings. Fan mode selection: ▶ Options: Auto - Dupty Cycle (default) or Manial - Dupty Cycle
Fan Alert Function	GPU Smart Fan function settings. Update CPU fan speed while system reboot: ▶ Options: Disabled (default) or Enabled CPU fan speed. Update GPU fan speed while system reboot: ▶ Options: Disabled (default) or Enabled CPU fan speed.

5.2.8. S5 RTC Wake Settings

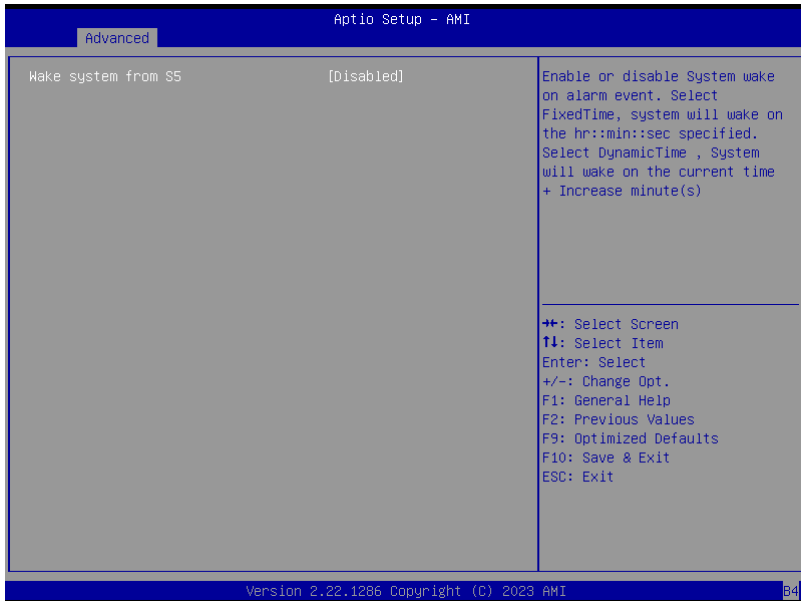

The features settings are:

Setting	Description
Wake System from S5	<p>Enable or Disable (default) system wake on alarm event.</p> <ul style="list-style-type: none"> Options available are: <ul style="list-style-type: none"> Disabled (default): Fixed Time: System will wake on the hr::min::sec specified. DynamicTime: If selected, you need to set Wake up minute increase from 1 - 5. System will wake on the current time + increase minute(s).

5.2.9. Serial Port Console Redirection

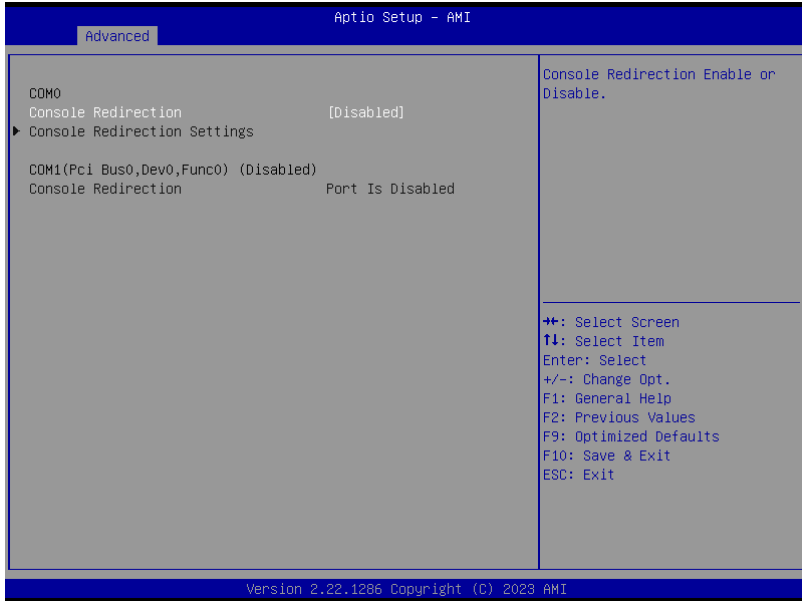

The features settings are:

Setting	Description
Console Redirection	Use this item to enable or disable Console Redirection. The optional settings: [Disabled] ; [Enabled] . When set as [Enabled] , user can make further settings in the following items:
Console Redirection EMS	Out-of-Band Mgmt Port The default setting is: [COM1] . ▶ Options: Do not launch (default) and UEFI

	<ul style="list-style-type: none">▶ Terminal Type EMS The optional settings: [VT100]; [VT100+]; [VT-UTF8]; [ANSI].▶ Bits per second EMS The optional settings: [9600]; [19200]; [57600]; [115200].▶ Flow Control EMS The optional settings: [None]; [Hardware RTS/CTS]; [Software Xon/Xoff]▶ Data Bits The default setting is: [8]▶ Parity The default setting is: [None]▶ Stop Bits The default setting is: [1]
--	---

Note: Legacy video can not be displayed in UEFI mode.

5.2.10. AMI Graphic Output Protocol Policy

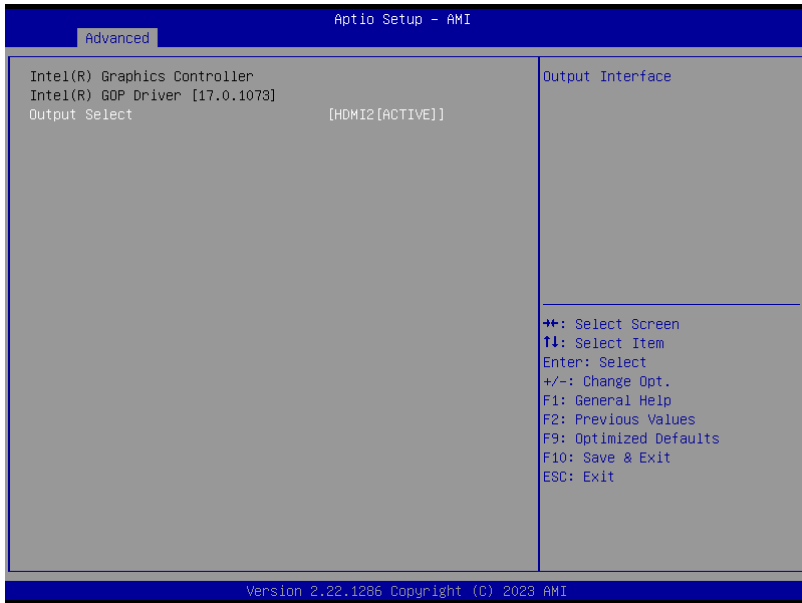

Access this submenu to select output interface.

The features settings are:

Setting	Description
Output select	Select Output Interface

5.2.11. USB Configuration

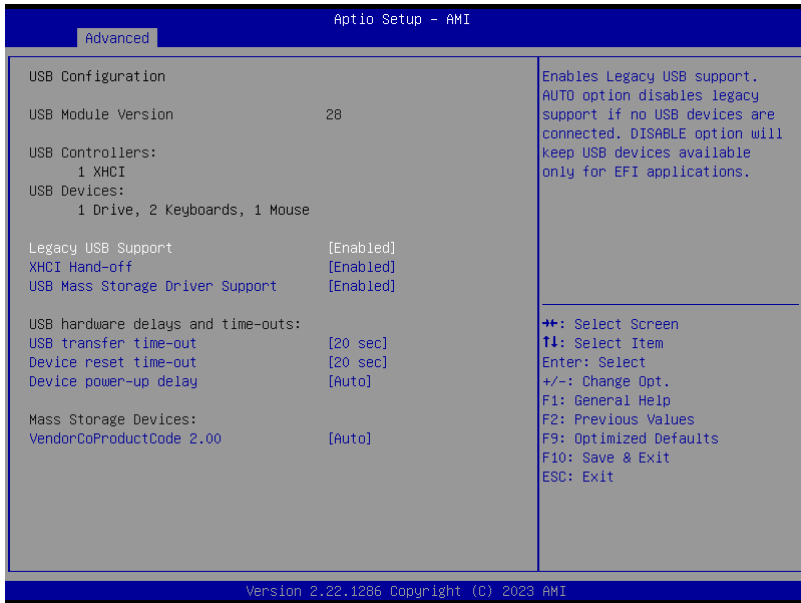

The features settings are:

Setting	Description
Legacy USB Support	<p>Enables/disables legacy USB support.</p> <ul style="list-style-type: none"> Options available are Enabled (default), Disabled and Auto. Select Auto to disable legacy support if no USB device are connected. Select Disabled to keep USB devices available only for EFI applications.
XHCI Hand-off	<p>This is a workaround for Oses without XHCI hand-off support. The XHCI ownership change should be claimed by XHCI driver.</p> <ul style="list-style-type: none"> The optional settings are: Enabled (default) / Disabled.
USB Mass Storage Driver support	<p>Enable / Disable USB Mass Storage Driver Support</p> <ul style="list-style-type: none"> The optional settings are: Enabled (default) / Disabled.

<p>USB Transfer time-out</p>	<p>Use this item to set the time-out value for control, bulk, and interrupt transfers. ► Options: 1 sec, 5 sec, 10 sec, 20 sec (default).</p>
<p>Device reset time-out</p>	<p>Use this item to set USB mass storage device start unit command time-out. ► Options available are: 10 sec, 20 sec (default), 30 sec, 40 sec</p>
<p>Device power-up delay</p>	<p>Use this item to set maximum time the device will take before it properly reports itself to the host controller. 'Auto' uses default value: for a root port it is 100 ms, for a hub port the delay is taken from hub descriptor. ► Options available are: Auto: Default Manual: Select Manual you can set value for the following sub-item: 'Device Power-up delay in seconds', the delay range in from 1 to 40 seconds, in one second increments.</p>
<p>VendorCoproduct Code 2.00</p>	<p>Mass storage device emulation type. "AUTO" enumerates devices according to their media format. Optical drives are emulated as "CDROM", drives with no media will be emulated according to a drive type. ► Options available are: Auto, Floppy, Forced FDD, Hard Disk, CD-ROM</p>

5.2.12. Network Stack Configuration



The features settings are:

Setting	Description
Network Stack	▶ Options are: [Enable] / [Disable] (default)

5.2.13. NVMe Configuration

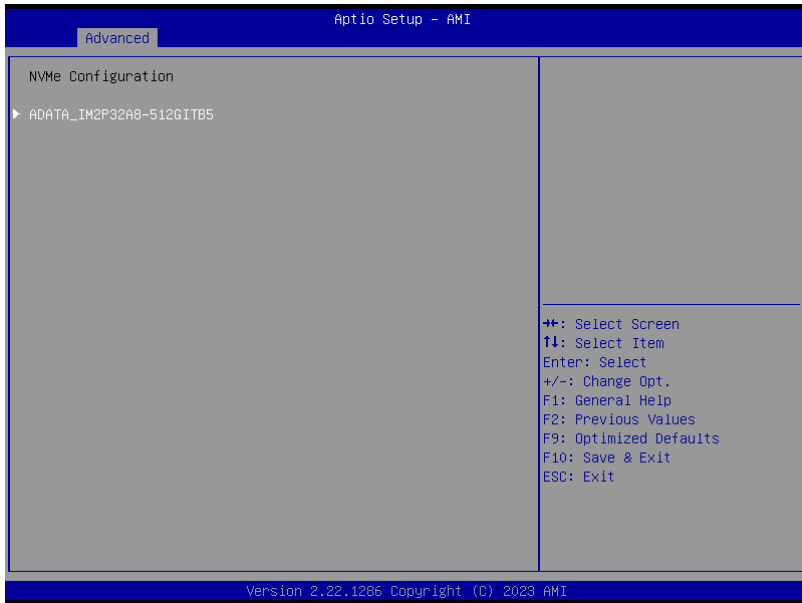

Access this submenu to view the NVMe controller and driver information.

5.3. Chipset

The **Chipset** menu controls the system's chipset.

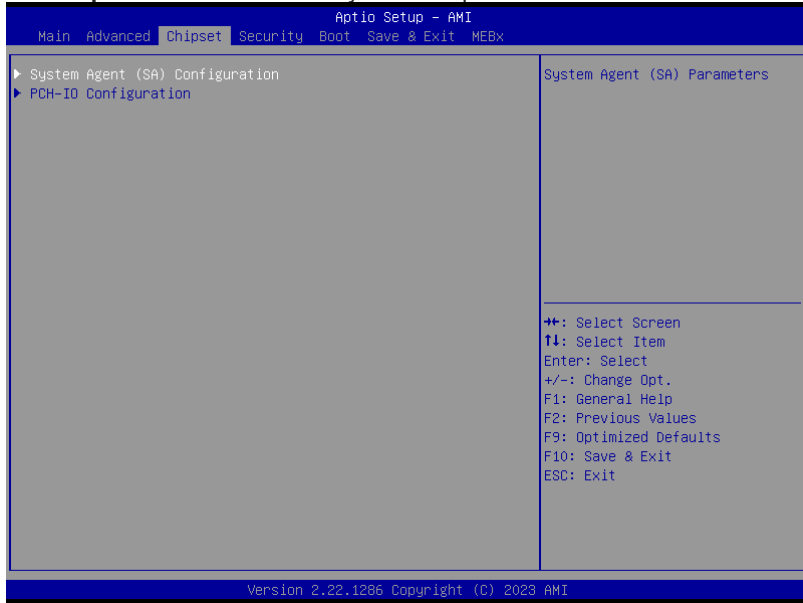

The features settings are:

Setting	Description
System Agent (SA) Configuration	
Memory Configuration	Access this submenu to view the memory configuration.

<p>Graphics Configuration</p>	<p>DP 1 Display: Select IGFX or MXM graphics device ▶ Options: IGFX DP(default) or MXM DP.</p> <p>DP 2 Display: Select IGFX or MXM graphics device ▶ Options: IGFX DP(default) or MXM DP.</p> <p>Primary Display: Select which of IGFX/PEG/PCI Graphics devices should be Primary Display or select HG for Hybrid Gfx. ▶ Options: Auto, IGFX, PEG Slot, PCH PCI, HG(default).</p> <p>Aperture Size: Select the Aperture Size ▶ Options: 128MB, 256MB, 512MB, 1024MB, 2048MB</p> <p>DVMT Pre-Allocated: Select DVMT 5.0 Pre-Allocated (Fixed) Graphics Memory size ▶ Options: 64M, 96M, 128M, 160M, 82M/F7, 36M, 40M, 44M, 48M, 52M, 56M, 60M</p>
<p>VMD Setup Menu</p>	<p>Enable / Disable to VMD controller ▶ Options: [Enabled] and [Disabled](default).</p>
<p>VT-d</p>	<p>VT-D capability ▶ Options: [Enabled] (default) or [Disabled] VT-d function</p>
<p>PCH-IO Configuration</p>	
<p>PCI Express Configuration</p>	<p>Press [Enter] to settings PCI Express Root Port Settings.</p>
<p>SATA And RST Configuration</p>	<p>See 5.3.1.2. SATA And RST Configuration on page 91</p>
<p>PCH-IO Configuration</p>	<p>[Enabled](default) / [Disabled] onboard NIC.</p>
<p>State After G3</p>	<p>Specify what state to go to when power is re-applied after a power failure (G3 state). ▶ The optional settings: [S0 State]; [S5 State]</p>

5.3.1.1. SATA Configuration

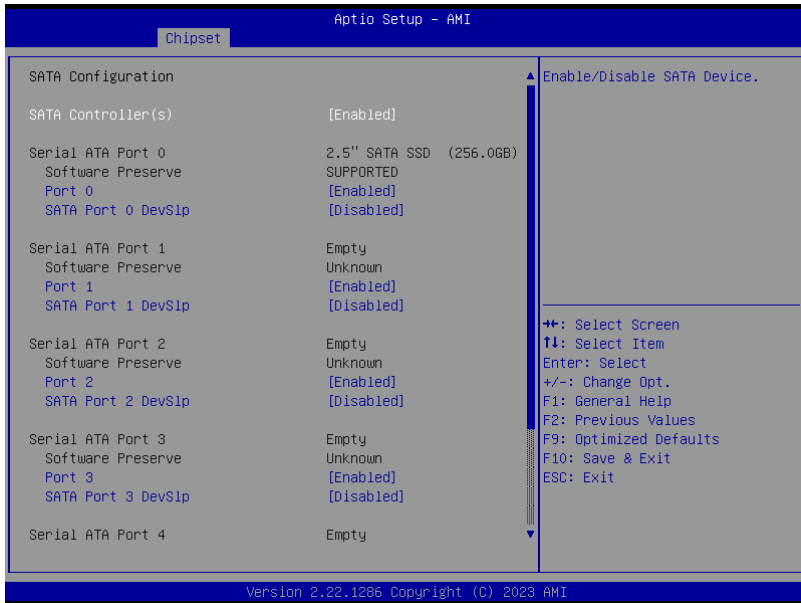

The features settings are:

Setting	Description
SATA Controller(s)	Enables (default) / Disables SATA device(s).
Serial ATA Port 0~6	SATA device information. Enables (default) / Disables the SATA port. *Available SATA ports depend on your model.
SATA Port 0~6 Devslp	Enables / Disables (default) SATA Port Device to sleep.

5.4. Security



The features settings are:

Setting	Description
<p>Administrator/ User Password</p>	<p>If ONLY the Administrator's password is set, then this only limits access to Setup and is only asked for when entering Setup. If ONLY the User's password is set, then this is a power on password and must be entered to boot or enter Setup. In Setup the User will have Administrator rights.</p> <p>The password must be less than 3 characters and no more than 20 characters.</p> <p>To set up an administrator/user password:</p> <ol style="list-style-type: none"> 1. Select Administrator/User Password. 2. An Create New Password dialog then pops up onscreen. 3. Enter your desired password that is no less than 3 characters and no more than 20 characters. 4. Hit [Enter] key to submit.

Secure Boot menu	<p>Secure Boot Press [Enter] to make customized secure settings: ▶ Options are: [Disabled] or [Enabled]</p> <p>Secure Boot Mode Secure Boot feature is Active if Secure Boot is Enabled: ▶ Options are: [Custom] or [Standard]</p> <p>Key Management ▶ This item enables expert users to modify Secure Boot Policy</p>
-------------------------	--

BIOS

5.5. Boot

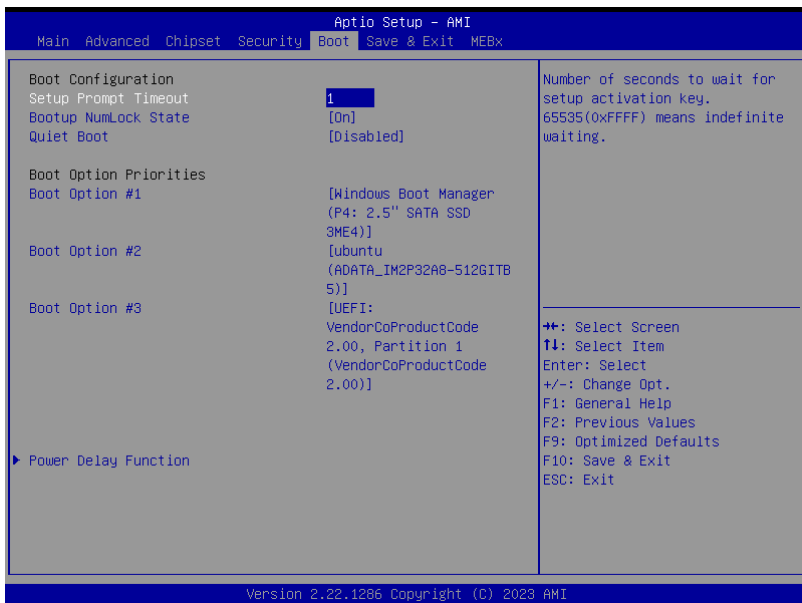

The features settings are:

Setting	Description
Setup Prompt Timeout	Set how long to wait for the prompt to show for entering BIOS Setup. <ul style="list-style-type: none">▶ The default setting is 1 (sec).▶ Set it to 65535 to wait indefinitely.
Bootup NumLock State	Sets whether to enable or disable the keyboard's NumLock state when the system starts up. <ul style="list-style-type: none">▶ Options available are On (default) and Off.
Quiet Boot	Sets whether to display the POST (Power-on Self Tests) messages or the system manufacturer's full screen logo during booting. <ul style="list-style-type: none">▶ Select Disabled to display the normal POST message, which is the default.
Boot Option Priority	Set the system boot priorities.

Power Delay Function**Power Delay Function**

Set the system support power delay function.

▶ Options:

Enable (default): Support power delay function.

Disable: Power on/off manually operated.

Power on delay

Select the time which the system will power on.

▶ Options: **Manually Operator** (default), **04 Seconds**, **08 Seconds** and **16 Seconds**.

Power off delay

Select the time which the system will power on.

▶ Options: **Manually Operator** (default), **30 Seconds**, **60 Seconds** and **90 Seconds**.

5.6. Save & Exit

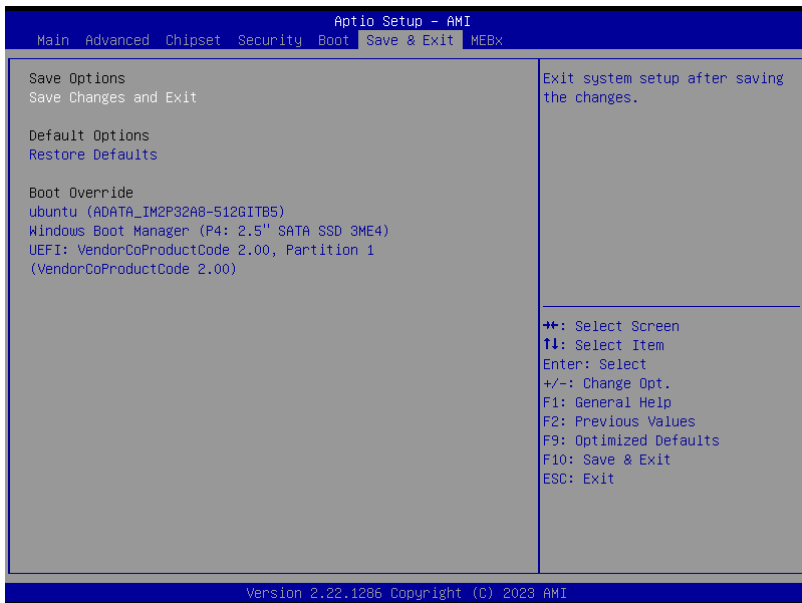

The features settings are:

Setting	Description
Save Changes and Exit	Saves the changes and quits the BIOS Setup utility.
Restore Defaults	Restores all settings to defaults. ▶ This is a command to launch an action from the BIOS Setup utility.
Boot Override	Boot Override presents a list in context with the boot devices in the system. ▶ P0 : Select the device to boot up the system regardless of the currently configured boot priority. ▶ UEFI : Attempts to launch EFI Shell Application (Shell.efi) from one of the available filesystem devices.

5.7. MEBx



The Intel MEBx provides the ability to change and/or collect the system hardware configuration.